

VLC user guide

Henri Fallon

Alexis de Lattre

Johan Bilien

Anil Daoud

Mathieu Gautier

Clément Stenac

Copyright © 2002, 2003 the VideoLAN project

This document is the complete user guide of VLC .

Permission is granted to copy, distribute and/or modify this document under the terms of the GNU Free Documentation License, Version 1.2 or any later version published by the Free Software Foundation ; with no Invariant Sections, with no Front-Cover Texts, and with no Back-Cover Texts. The text of the license can be found in the appendix *GNU Free Documentation License*.

Table of Contents

Chapter 1. Introduction	1
<u>1.1. What is the VideoLAN project ?</u>	1
1.1.1. Overview.....	1
1.1.2. VideoLAN software.....	2
1.2. What is a codec ?.....	3
1.3. How can I use VideoLAN ?.....	3
1.3.1. Documentation.....	3
1.3.2. User support.....	4
1.4. Command line usage.....	4
1.4.1. Open a terminal.....	4
Chapter 2. Modules and options for VLC	8
2.1. The modules.....	8
2.2. Video outputs.....	8
2.2.1. x11.....	8
2.2.2. xvideo.....	9
2.2.3. sdl.....	9
2.2.4. directx.....	9
2.2.5. wingdi.....	9
2.2.6. fb.....	9
2.2.7. glide.....	10
2.2.8. mga.....	10
2.2.9. ggi.....	10
2.2.10. aa.....	10
2.2.11. ssvgalib.....	10
2.2.12. qte.....	10
2.3. Video filters modules.....	10
2.3.1. deinterlace.....	11
2.3.2. wall.....	11
2.3.3. distort.....	11
2.3.4. transform.....	11
2.3.5. invert.....	11
2.3.6. adjust.....	11
2.3.7. clone.....	11
2.3.8. crop.....	12
2.3.9. motionblur.....	12
2.4. Audio outputs.....	12
2.4.1. oss.....	12
2.4.2. alsa.....	12
2.4.3. esd.....	12
2.4.4. arts.....	13
2.4.5. waveout.....	13
2.4.6. coreaudio.....	13
2.4.7. sdl.....	13
2.5. Input modules.....	13
2.5.1. dvdplay.....	13
2.5.2. dvd.....	13
2.5.3. dvdread.....	14

Table of Contents

Chapter 2. Modules and options for VLC

<u>2.5.4. vcd</u>	14
<u>2.5.5. cdda</u>	14
<u>2.5.6. http.ftp.udp.file.directory.mms</u>	14
<u>2.5.7. satellite</u>	14
<u>2.5.8. v4l</u>	14
<u>2.5.9. dvb</u>	14
<u>2.5.10. pvr</u>	15
<u>2.5.11. slp</u>	15
<u>2.6. Demuxers</u>	15
<u>2.6.1. avi</u>	15
<u>2.6.2. asf</u>	15
<u>2.6.3. aac</u>	15
<u>2.6.4. ogg</u>	15
<u>2.6.5. rawdv</u>	16
<u>2.6.6. dvbpsi</u>	16
<u>2.6.7. mp4</u>	16
<u>2.6.8. mkv</u>	16
<u>2.6.9. ps.ts</u>	16
<u>2.6.10. id3,m3u</u>	16
<u>2.7. Interface modules</u>	16
<u>2.7.1. wxwindows</u>	17
<u>2.7.2. skins</u>	17
<u>2.7.3. gtk</u>	17
<u>2.7.4. gnome</u>	17
<u>2.7.5. qt</u>	17
<u>2.7.6. kde</u>	17
<u>2.7.7. rc</u>	18
<u>2.7.8. http</u>	18
<u>2.7.9. ncurses</u>	18
<u>2.7.10. lirc</u>	18
<u>2.7.11. opie</u>	18
<u>2.7.12. gestures</u>	18
<u>2.7.13. joystick</u>	19
<u>2.8. Codec modules</u>	19
<u>2.8.1. a52</u>	19
<u>2.8.2. ffmpeg</u>	19
<u>2.8.3. vorbis</u>	19
<u>2.8.4. xvid</u>	19
<u>2.8.5. mad</u>	19
<u>2.8.6. libmpeg2</u>	20
<u>2.8.7. faad</u>	20
<u>2.8.8. tarkin</u>	20
<u>2.8.9. theora</u>	20
<u>2.8.10. cinepak</u>	20
<u>2.8.11. tremor</u>	20
<u>2.9. OS support modules</u>	20
<u>2.9.1. macosx</u>	20

Table of Contents

Chapter 2. Modules and options for VLC

<u>2.9.2. qnx</u>	21
2.10. <u>Miscellaneous</u>	21
<u>2.10.1. sout</u>	21
<u>2.10.2. test-suite</u>	21
<u>2.10.3. mozilla</u>	21
<u>2.10.4. xosd</u>	21
2.11. <u>Compilation Options</u>	21
<u>2.11.1. --disable-plugins</u>	22

Chapter 3. Installing VLC.....23

3.1. <u>Installing VLC</u>	23
<u>3.1.1. Windows</u>	23
<u>3.1.2. BeOS</u>	23
<u>3.1.3. Mac OS X</u>	23
<u>3.1.4. Debian GNU/Linux</u>	23
<u>3.1.5. Linux Mandrake</u>	24
<u>3.1.6. Linux Redhat</u>	24
<u>3.1.7. Compile the sources by yourself (for every other OS)</u>	24
3.2. <u>Uninstalling VLC</u>	26
<u>3.2.1. Windows</u>	26
<u>3.2.2. BeOS</u>	26
<u>3.2.3. Mac OS X</u>	26
<u>3.2.4. Debian GNU/Linux</u>	26
<u>3.2.5. GNU/Linux Redhat, Mandrake and SuSE</u>	26
<u>3.2.6. If you compiled VLC from sources</u>	26

Chapter 4. The command line interface.....27

4.1. <u>Introduction</u>	27
4.2. <u>Opening streams</u>	27
<u>4.2.1. Opening a file</u>	27
<u>4.2.2. Opening a DVD or VCD, or an audio CD</u>	27
<u>4.2.3. Start a network stream</u>	27
4.3. <u>Modules selection</u>	28
4.4. <u>Stream Output</u>	28
<u>4.4.1. Description of the stream output</u>	28
<u>4.4.2. Architecture and syntax</u>	28
<u>4.4.3. Description of the modules</u>	29
<u>4.4.4. Examples</u>	31
4.5. <u>Other Options</u>	31
<u>4.5.1. Audio options</u>	31
<u>4.5.2. Video options</u>	31
<u>4.5.3. Playlist options</u>	32
<u>4.5.4. Network options</u>	32
<u>4.5.5. CPU options</u>	32
<u>4.5.6. Miscellaneous options</u>	32
<u>4.5.7. Help options</u>	32

Table of Contents

<u>Chapter 5. The Mozilla plugin</u>	33
<u>5.1. Install the plugin</u>	33
<u>5.1.1. GNU/Linux Debian</u>	33
<u>5.1.2. Compile the sources yourself</u>	33
<u>5.2. Build HTML pages that use the plugin</u>	33
<u>5.2.1. Example 1</u>	33
<u>5.2.2. Example 2</u>	34
<u>Appendix A. GNU Free Documentation License</u>	35
<u>A.1. PREAMBLE</u>	35
<u>A.2. APPLICABILITY AND DEFINITIONS</u>	35
<u>A.3. VERBATIM COPYING</u>	36
<u>A.4. COPYING IN QUANTITY</u>	37
<u>A.5. MODIFICATIONS</u>	37
<u>A.6. COMBINING DOCUMENTS</u>	38
<u>A.7. COLLECTIONS OF DOCUMENTS</u>	39
<u>A.8. AGGREGATION WITH INDEPENDENT WORKS</u>	39
<u>A.9. TRANSLATION</u>	39
<u>A.10. TERMINATION</u>	40
<u>A.11. FUTURE REVISIONS OF THIS LICENSE</u>	40
<u>A.12. ADDENDUM: How to use this License for your documents</u>	40

Chapter 1. Introduction

1.1. What is the VideoLAN project ?

1.1.1. Overview

VideoLAN is a complete software solution for video streaming, developed by students of the Ecole Centrale Paris and developers from all over the world, under the GNU General Public License (GPL). VideoLAN is designed to stream MPEG videos on high bandwidth networks.

The VideoLAN solution includes :

- VLS (VideoLAN Server), which can stream MPEG-1, MPEG-2 and MPEG-4 files, DVDs, digital satellite channels, digital terrestrial television channels and live videos on the network in unicast or multicast,
- VLC (initially VideoLAN Client), which can be used as a server to stream MPEG-1, MPEG-2 and MPEG-4 files, DVDs and live videos on the network in unicast or multicast ; or used as a client to receive, decode and display MPEG streams under multiple operating systems.

Here is an illustration of the complete VideoLAN solution :

Figure 1-1. Global VideoLAN solution La solution VideoLAN globale

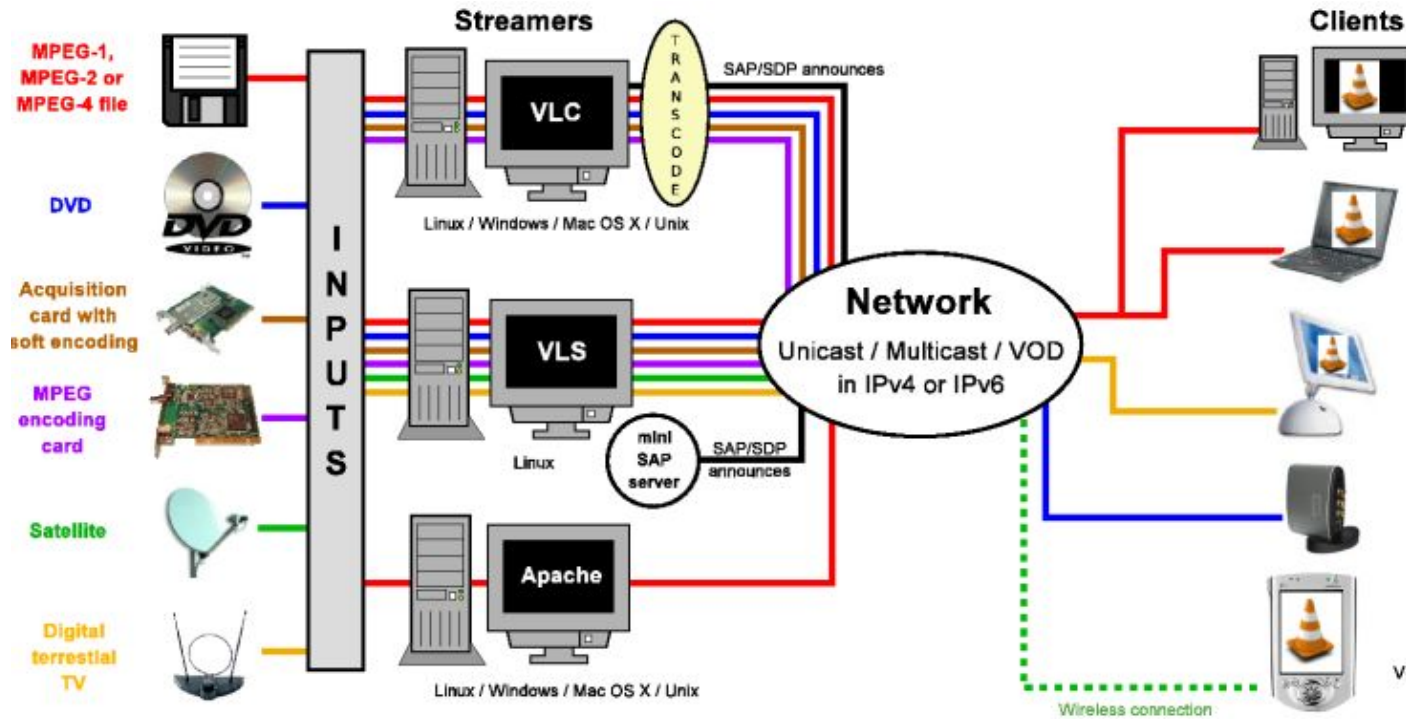

More details about the project can be found on the [VideoLAN Web site](#).

1.1.2. VideoLAN software

1.1.2.1. VLC

VLC works on many platforms : Linux, Windows, Mac OS X, BeOS, *BSD, Solaris, Familiar Linux, Yopy/Linupy and QNX. It can read :

- MPEG-1, MPEG-2 and MPEG-4 / DivX files from a hard disk, a CD-ROM drive, ...
- DVDs and VCDs,
- from a satellite card (DVB-S),
- MPEG-1, MPEG-2 and MPEG-4 streams from the network sent by VLS or VLC's stream output.

VLC can also be used as a server to stream :

- MPEG-1, MPEG-2 and MPEG-4 / DivX files,
- DVDs,
- from an MPEG encoding card,

to :

- one machine (i.e. to one IP address) : this is called *unicast*,
- a dynamic group of machines that the clients can join or leave (i.e. to a multicast IP address) : this is called *multicast*,

in IPv4 or IPv6 .

To get the complete list of VLC's possibilities on each platform supported, see the [VLC features page](#).



VLC doesn't work on Mac OS 9, and will probably never do.

1.1.2.2. VLS

VLS can stream :

- an MPEG-1, MPEG-2 or MPEG-4 files stored on a hard drive or on a CD,
- a DVD located in a local DVD drive or copied on a hard disk,
- a satellite card (DVB-S) or a digital terrestrial television card (DVB-T) ,
- an MPEG encoding card ;

to:

- one machine (i.e. to one IP address) : this is called *unicast*,
- a dynamic group of machines that the clients can join or leave (i.e. to a multicast IP address) : this is called *multicast*,

in IPv4 or IPv6 .

A Pentium 100 MHz with 32 MB of memory should be enough to send one stream on the network. When streaming a lot of videos stored on a hard drive, the actual limitation is not the processor but the hard drive and the network connection.

VLS works under Linux and Windows. To get the complete list of VLS's possibilities on each platform supported, see the [streaming features page](#).

1.1.2.3. Mini-SAP-server

You can add a channel information service based on the SAP/SDP standard to the VideoLAN solution. The mini-SAP-server sends announces about the multicast programs on the network in IPv4 or IPv6, and VLCs receive these announces and automatically add the programs announced to their playlist.

The mini-SAP-server works under Linux and Mac OS X.

1.2. What is a codec ?

To fully understand the VideoLAN solution, you must understand the difference between a *codec* and a *container format*

- A *codec* is a compression algorithm, used to reduce the size of a stream. There are audio codecs and video codecs. MPEG-1, MPEG-2, MPEG-4, Vorbis, DivX, ... are codecs
- A *container format* contains one or several streams already encoded by codecs. Very often, there is an audio stream and a video one. AVI, Ogg, MOV, ASF, ... are container formats. The streams contained can be encoded using different codecs. In a perfect world, you could put any codec in any container format. Unfortunately, there are some incompatibilities. You can find a matrix of possible codecs and container formats on the [features page](#)

To decode a stream, VLC first *demuxes* it. This means that it reads the container format and separates audio, video, and subtitles, if any. Then, each of these are passed *decoders* that do the mathematical processing to decompress the streams .

There is a particular thing about MPEG:

- MPEG is a *codec*. There are several versions of it, called MPEG-1, MPEG-2, MPEG-4, ...
- MPEG is also a container format, sometimes referred to as *MPEG System*. There are several types of MPEG: ES, PS, and TS

When you play an MPEG video from a DVD, for instance, the MPEG stream is actually composed of several streams (called Elementary Streams, ES): there is one stream for video, one for audio, another for subtitles, and so on. These different streams are mixed together into a single Program Stream (PS). So, the .VOB files you can find in a DVD are actually MPEG-PS files. But this PS format is not adapted for streaming video through a network or by satellite, for instance. So, another format called Transport Stream (TS) was designed for streaming MPEG videos through such channels.

1.3. How can I use VideoLAN ?

1.3.1. Documentation

The user documentation of VideoLAN is made up of 4 documents :

- the *VideoLAN Quickstart*. This document will give you a quick overview of of VLC, VLC's stream output, the Video On Demand solution and the channel information service system.

VLC user guide

- the *VideoLAN HOWTO*. This document is the complete guide of the VideoLAN streaming solution.
- the *VLC user guide*. This document is the complete guide for VLC.
- the *VLS user guide*. This document is the complete guide for VLS.
- the *VideoLAN FAQ*. This document contains Frequently Asked Questions about VideoLAN.

The latest version of these documents can be found on the [documentation page](#) .

You can also have a look at the [VideoLAN Wiki](#). This is a website that everyone can change. We use it to document everything that is not in the "official" documentation: the tips and tricks for each O.S., the graphical interfaces, etc...

1.3.2. User support

If you have problems using VideoLAN, and if you don't find the answer to your problems in the documentation, please look at the [online archive of the mailing-lists](#). There are two English-speaking mailing-lists for the users :

- vlc@videolan.org for the questions on VLC ,
- streaming@videolan.org for the questions on VLS, mini-SAP-server and the network .

If you want to subscribe or unsubscribe to the mailing-lists, please go to the [mailing-list page](#).

You can also talk with VideoLAN users and developers on IRC : server [irc.freenode.net](irc://irc.freenode.net), channel [#videolan](#) .

If you find a bug, please follow the instructions on the [bug reporting page](#) .

1.4. Command line usage

- VLC has many different graphical interfaces, that are organized quite differently in order to be in harmony with the guidelines of each operating system supported. Documenting the use of each graphical interface is too long, and some features are only available via the command line interface. Therefore we decided to document only the command line interface, but in many cases it should be easy to guess how to use the graphical interface for the same use !
- VLS has a command line and a telnet interface, but no graphical interface !

All the commands that show up in this document should be typed inside a terminal. .

1.4.1. Open a terminal

1.4.1.1. Windows

Click on *Start, Run* and type :

- **cmd Enter** (Windows 2000 / XP),
- **command Enter** (Windows 95 / 98 / ME).

The terminal appears Le terminal apparait

Figure 1–2. Windows terminal

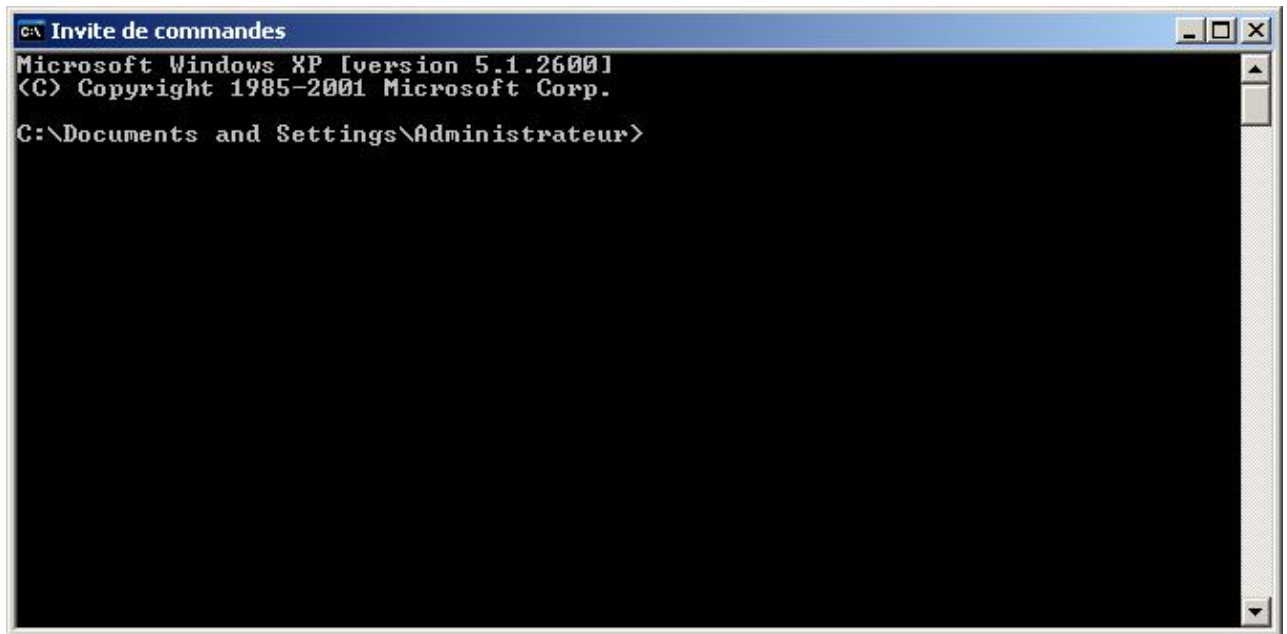

 Under Windows, you need to be in the directory where the program is installed to run it.

1.4.1.2. Linux / Unix

Open a terminal :

Figure 1–3. Linux X terminal



In the documentation, we adopt the following conventions for the Unix commands :

- commands that should be typed as *root* have a # prompt :

```
# command_to_be_typed_as_root
```

- commands that should be typed as a regular user have a % prompt :

```
% command_to_be_typed_as_regular_user
```

1.4.1.3. Mac OS X

Go to *Applications*, open the folder *Utilities* and double-click on *Terminal* :

Figure 1–4. Mac OS X terminal

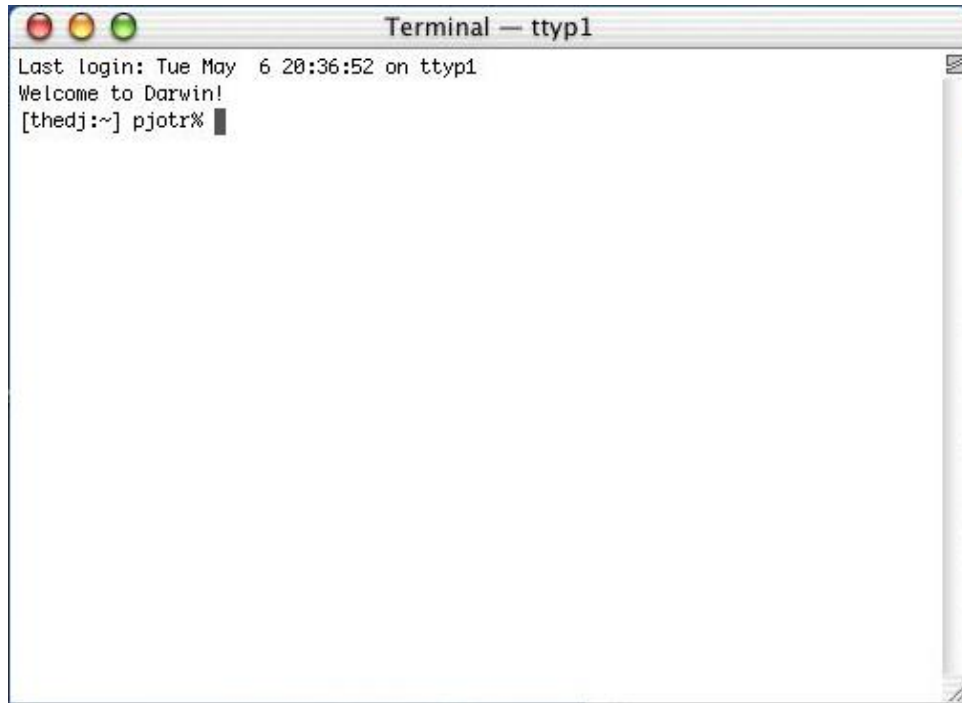

 Under Mac OS X, you need to be in the directory where the program is installed to run it, and start the command with `./`.

1.4.1.4. BeOS

In the deskbar, go to *Application* and then *Terminal* :

Figure 1–5. BeOS terminal

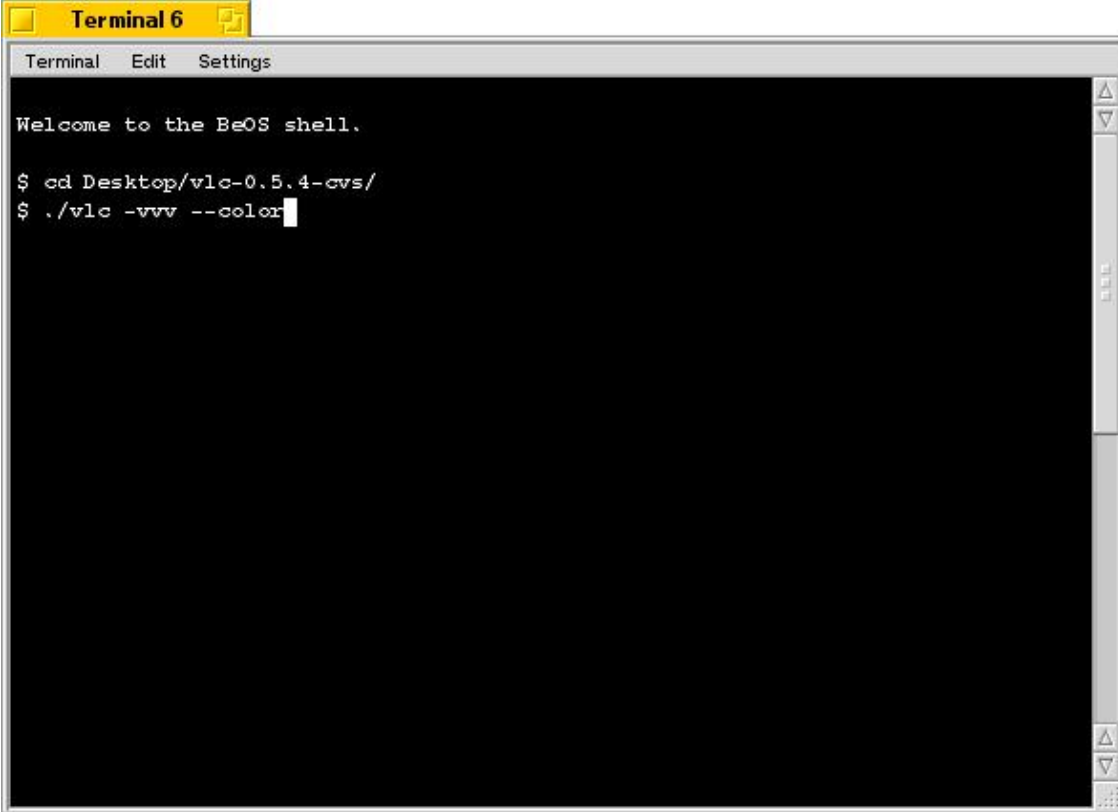

```
Terminal 6
Terminal Edit Settings
Welcome to the BeOS shell.
$ cd Desktop/vlc-0.5.4-cvs/
$ ./vlc -vvv --color
```

 Under BeOS, you need to be in the directory where the program is installed to run it, and start the command with `./`.

Chapter 2. Modules and options for VLC

2.1. The modules

VLC uses a modular system, which allows to add easily new fonctions and formats. Here is a description of nearly all the VLC modules. A few "internal" modules won't be explained here. For a complete list of all VLC modules, please have a look at the LIST file in the subdirectory "modules" of the VLC source tree.

If you installed VLC through a binary file, you will get the default modules. If, however, you want to customize VLC to your needs, you will have to compile VLC from sources.

If you don't intend to compile VLC and want only the regular functions, reading this part is not very useful.

The compilation itself is explained in the next chapter.

If you wish to compile a module which is stated *disabled by default*, you have to launch the configure script with :

```
% ./configure
--enable-module_name
```

On the other hand, if you would like to disable a module that is *enabled by default*, you would have to use :

```
% ./configure
--disable-module_name
```

Each VLC module has its own help and options. To see what options are associated with a module, use :

```
% vlc -p
module_name
```

or use the "Preferences" Panel of your favorite graphical interface .

2.2. Video outputs

Video outputs are the modules that enable the support of some systems to display the video on your screen.

2.2.1. x11

default: enabled

For Unix with X11 servers only

This is the basic x11 video output. It only requires a working X11 server. You will need xlibs headers to compile it (*xlibs-dev* package on Debian systems).

2.2.2. xvideo

default: enabled

For GNU/Linux only

It requires an xvideo compliant graphic card (it is the case for nearly all modern cards). It uses hardware acceleration for YUV transformation and rescaling.

2.2.3. sdl

default: enabled

This video output uses sdl libraries. You need at least version 1.1.6 of this libraries.

You may indicate the path to the *sdl-config* program with the `--with-sdl-config-path=PATH` switch, when running the configure script.

2.2.4. directx

default: enabled on win32

For Windows only

This video output uses Microsoft Direct X libraries. It is recommended for the win32 port.

You may indicate the path to directX libraries and headers with the `--with-directx=PATH` switch, when running the configure script.

2.2.5. wingdi

default: enabled on win32

For Windows only

This video output uses GDI. It is designed for users who don't have Direct X, but the perfs are very low. If you have DirectX, do not use it.

2.2.6. fb

default: enabled on GNU/Linux

For GNU/Linux only

This is the frame buffer video output. It requires that your kernel was compiled with frame buffer support.

2.2.7. glide

default: disabled

This video output uses Glide libraries (hardware acceleration for 3Dfx cards).

You may indicate the path to the library with the `--with-glide=PATH` configure option.

2.2.8. mga

default: disabled

For GNU/Linux only

This module provides hardware acceleration for Matrox cards under GNU/Linux.

2.2.9. ggi

default: disabled

2.2.10. aa

default: disabled

This is the ASCII Art Video Output. This video output uses the aalib library to display video through ASCII art. It requires aalib headers (*aalib1-dev* package under Debian GNU/Linux) to compile.

2.2.11. svgalib

default: disabled

For GNU/Linux only

This is a video output for the SVGALib library.

2.2.12. qte

default: disabled

For iPaq only

This is a video output for QT Embedded, an iPaq-specific graphical library .

2.3. Video filters modules

These modules allow you to perform modifications on the rendered image .

2.3.1. deinterlace

Always enabled

This filter deinterlaces video. It is useful with streams coming from a digital satellite channel or digital terrestrial television channels .

2.3.2. wall

Always enabled

This filter allows you to have the video cut in pieces in several windows, which you can order as you wish. It can be used to generate image walls with several sources.

2.3.3. distort

Always enabled

This filter adds a distortion effect to the video. Who said it was useless ? :-)

2.3.4. transform

Always enabled

This filter allows to rotate the video in several ways .

2.3.5. invert

Always enabled

This filter inverses colors.

2.3.6. adjust

Always enabled

This filter allows you to set image contrast, hue, saturation and brightness

2.3.7. clone

Always enabled

Ce filtre vous permet de dupliquer l'image.

2.3.8. crop

Always enabled

This filter allows you to crop parts of the image.

2.3.9. motionblur

Always enabled

This filter adds a "motion blur" effect to the image.

2.4. Audio outputs

These modules allow you to choose the way the sound will be output to your audio system .

2.4.1. oss

default: enabled on GNU/Linux

For GNU/Linux and Unix only

This is the audio output for OSS (Open Sound System) output (`/dev/dsp`, for example, under Linux). It requires that your kernel was compiled with support for your sound card, or, if you use ALSA (Advanced Linux Sound System), the OSS emulation layer must be active.

2.4.2. alsa

default: disabled

For GNU/Linux only

This is the sound output for ALSA (Advanced Linux Sound Architecture). It only works under Linux, and it requires that you installed the ALSA drivers and libraries.

2.4.3. esd

default: disabled

For GNU/Linux & Unix only

This sound output has ESD (Enlightened Sound Daemon) support (usually used with Gnome). You must have the daemon and its libraries installed.

2.4.4. arts

default: disabled

For GNU/Linux & Unix only

This sound output has aRts (KDE's sound server) support. You must have the daemon and its libraries installed .

2.4.5. waveout

default: enabled on win

For Windows only

This is the Wave output, which is used by the win32 port.

2.4.6. coreaudio

default: enabled on Mac OS X

For Mac OS X only

This audio output uses CoreAudio under Mac OS X

2.4.7. sdl

default: enabled

This audio output uses SDL. Please refer to the video output.

2.5. Input modules

These modules allow VLC to read its streams from different sources .

2.5.1. dvdplay

default: enabled

This is the regular DVD input module. It will need *libdvdcss* for DVD decryption (see the [libdvdcss page](#)) and *libdvdplay* for DVD navigation (see the [libdvdplay page](#)) .

2.5.2. dvd

default: enabled

This is the old DVD input module. It uses *libdvdcss* for DVD decryption (see the [libdvdcss page](#)) .

2.5.3. dvdread

default: disabled

This is an alternative to the previous ones. It uses *libdvdread* for DVD reading (see the [Ogle download page](#)) and *libdvdcss* for DVD decryption (see the [libdvdcss page](#)).

2.5.4. vcd

default: enabled

This is the VideoCD input .

2.5.5. cdda

default: enabled

This is the Audio CD input .

2.5.6. http,ftp,udp,file,directory,mms

Always enabled

These are standard input modules. The HTTP input can be used for Video On Demand .

2.5.7. satellite

default: disabled

This is an input module that allows to read directly from a Hauppauge WinTV Nova card under GNU/Linux. It requires drivers 0.9.4 available from [linuxtv.org](#) .

2.5.8. v4l

default: disabled

For GNU/Linux only

This module allows to get Video4Linux streams .

2.5.9. dvb

default: disabled

For GNU/Linux only

This module allows to read from DVB-S, DVB-T, and DBC-C satellite, digital terrestrial, or cable cards. It uses the Video4Linux 2 API, that is only available in kernel 2.5.X and 2.6.X .

2.5.10. pvr

default: disabled

For GNU/Linux only

This module allows to read from Hauppauge PVR cards .

2.5.11. slp

default: enabled

This module allows to get the names and addresses for streams announced using the SLP protocol

2.6. Demuxers

In a video stream, the video signal and the audio one are always into "containers" formats. Demuxers extract the streams from it and pass it to the decoders .

For example, an AVI file can contain a MPEG-4 video, or an uncompressed video. AVI is only a storing format, not a compression format .

2.6.1. avi

Always enabled

This module allows you to read .avi files .

2.6.2. asf

Always enabled

This module allows you to read .asf files

2.6.3. aac

Always enabled

This module allows you to read AAC files

2.6.4. ogg

default: enabled

This module allows you to read .ogg files

2.6.5. rawdv

Always enabled

This module allows you to read DV files

2.6.6. dvbpsi

default: enabled

This module allows to demux streams from a satellite card.

2.6.7. mp4

Always enabled

This module allows you to read .mp4 files

2.6.8. mkv

default: enabled

This module allows you to read files that use the Matroska free format .

2.6.9. ps,ts

Always enabled

These modules allow you to read MPEG2 Program Stream or Transport Tream files .

2.6.10. id3,m3u

Always enabled

These modules allow you to read M3U, B4S, PLS, and ASX playlists, and ID3 tags .

2.7. Interface modules

These modules allow you to choose the interface or interfaces you want to use (whether graphical or control interfaces).

2.7.1. wxwindows

default: enabled

The wxWindows interface is a portable interface that is currently working under GNU/Linux and Windows. It is now the best graphical interface available under both Windows and GNU/Linux .

2.7.2. skins

default: enabled on win32

This skinnable interface module works under Win32 and X11. You can create your own skins very easily with XML files .

2.7.3. gtk

default: enabled

This is the GTK+ interface. It needs gtk libraries and headers files if you are compiling it. Note that it can also be used under Windows .

2.7.4. gnome

default: disabled

For GNU/Linux only

This is the Gnome interface. It needs gnome libraries (*libgnome32* package under Debian) and headers (*libgnome-dev* package under Debian) if you wish to compile it .

2.7.5. qt

default: disabled

This is the QT interface module. You will need the libraries (*libqt2* package on Debian) and headers (*libqt-dev* package under Debian) if you wish to compile it .

2.7.6. kde

default: disabled

For GNU/Linux only

This is the KDE interface module. You will need the libraries (*kdelibs3* package on Debian) and headers (*kde-devel* package under Debian) if you wish to compile it .

2.7.7. rc

Always enabled

This is the Remote Control interface module. It allows you to control VLC via commands, such as *play*, *stop*, etc... or via a script. This interface is text-based, so you should use it when you are in console mode .

2.7.8. http

Always enabled

This module allows you to remote control your VLC via a web browser. You can create custom web pages. [More info here](#) .

2.7.9. ncurses

default: disabled

For GNU/Linux only

This is a text interface, using ncurses library. You will need ncurses headers if you want to compile it (*libncurses5-dev* package on Debian) .

2.7.10. lirc

default: disabled

For GNU/Linux only

This interface module allows you to control VLC through a remote. A *lircrc* example is provided to help you configure it to your remote (see *doc/lirc/example.lircrc*) .

2.7.11. opie

default: disabled

This is an interface plugin for the Qt Embedded library (iPaq graphical library) .

2.7.12. gestures

Always enabled

This module allows you to control VLC via mouse gestures .

2.7.13. joystick

default: disabled

For GNU/Linux only

This module allows you to control VLC via a joystick with many options. More information can be found [here](#) .

2.8. Codec modules

The following modules add codec (ie, compression formats) support .

2.8.1. a52

default: enabled

This decoder uses liba52 (see the [liba52 web site](#) .

2.8.2. ffmpeg

default: enabled

This is a free MPEG-4/DivX/OpenDivX codec : ffmpeg (see the [ffmpeg web site](#)) .

2.8.3. vorbis

default: enabled

This codec allows you to read the Vorbis (audio) encoded files .

2.8.4. xvid

default: disabled

This codec allows you to read files encoded with Xvid (see [Xvid web site](#)) .

2.8.5. mad

default: enabled

This codec is a very smart MP3 decoder, that only uses integers. This allows its use for CPU which don't handle floating point numbers (on PDA, for example) .

2.8.6. libmpeg2

default: enabled

This codec allows to read MPEG2 files .

2.8.7. faad

default: disabled

Faad is an MPEG-4 audio decoder .

2.8.8. tarkin

default: disabled

tarkin is a new codec (experimental) by the Ogg Project (see the [Ogg Vorbis web site](#)) .

2.8.9. theora

default: disabled

theora is a new codec (experimental) by the Ogg Project (see the [Ogg Vorbis web site](#)) .

2.8.10. cinepak

default: enabled

This codec decodes the Cinepak format .

2.8.11. tremor

default: disabled

This is an Ogg/Vorbis codec that only makes integer calculus, which allow its use on CPU which don't have floating point support (see the [Ogg Vorbis web](#) .

2.9. OS support modules

The following modules add support for different OSs .

2.9.1. macosx

This is the MacOS X support module, including a native interface .

2.9.2. qnx

This is the QNX RTOS support module .

2.10. Miscellaneous

This section describes a few more modules that don't belong to any of the categories described before .

2.10.1. sout

default: enabled

Stream Output is a new feature of VLC that allows it to stream an MPEG-1, MPEG-2 or MPEG-4/DivX file or a DVD .

For more details, please have a look at the [The command line interface](#) section .

2.10.2. test-suite

default: disabled

This builds a special VLC, for testing purposes only .

2.10.3. mozilla

default: disabled

This is not really a module. When enabled, a VLC-based Mozilla plugin is built .

2.10.4. xosd

default: disabled

For Unix only

This plugin outputs the current stream to an "OSD" (On Screen Display) .

2.11. Compilation Options

There are a few options that you can set when running the configure script, which are not related to modules .

You can have a look at these options by typing :

```
% ./configure --help
```

You can for example control all the installation directories, the system for which you want to build VLC for (if not guessed correctly),...

You can also choose to enable or disable some optimizations.

2.11.1. `--disable-plugins`

If you select this option, no plugins will be enabled. This is definitely not recommended, as you would get a very poor VLC, and should only be used for testing purposes .

Chapter 3. Installing VLC

3.1. Installing VLC

There are VLC binaries available for the many OSES, but not for all supported OSES. If there are no binaries for your OS or if you want to change the default settings, you can compile VLC from sources.

3.1.1. Windows

VLC works under Windows 95/98/ME/2000/XP. Download the self-extracting file from the [VLC Windows download page](#). Launch the .exe to install VLC.

3.1.2. BeOS

Download the Zip file from the [VLC BeOS download page](#). Unzip the file in a directory to install VLC.

3.1.3. Mac OS X

Download the Mac OS X package from the [VLC MacOS X download page](#). Double-click on the icon of the package: an icon will appear on your Desktop, right beside your drive(s). Open it and drag the VLC application from the resulting window to the place where you want to install it (it should be /Applications).

3.1.4. Debian GNU/Linux

3.1.4.1. Debian stable (woody)

Add the following lines to your `/etc/apt/sources.list`:

```
deb http://www.videolan.org/pub/videolan/debian $(ARCH)/
deb-src http://www.videolan.org/pub/videolan/debian sources/
```

Then, for a normal install, do:

```
# apt-get update
# apt-get install gnome-vlc libdvdcss2
```

3.1.4.2. Debian unstable (sid)

Add the following lines to your `/etc/apt/sources.list`:

```
deb http://www.videolan.org/pub/videolan/debian $(ARCH)/
deb-src http://www.videolan.org/pub/videolan/debian sources/
```

Then, for a normal install, do:

```
# apt-get update
# apt-get install wxvlc libdvdcss2
```

3.1.4.3. Debian testing (sarge)

You should not be using Debian testing unless you perfectly know what you are doing. It is almost impossible to support Debian testing and there are no plans to do it. For more informations on Debian testing, please look: [testing page](#)

3.1.5. Linux Mandrake

There are VLC packages for Mandrake 9.1 and cooker.

To install them, add the following sources for either Mandrake 9.1 or Cooker (you can use [Easy urpmi](#) for that): *contrib* from the core distribution and *plf* (Penguin Liberation Front) from the external add-ons.

Then install the required packages with **urpmi**:

```
# urpmi libdvdcss2 libdvdplay0 wxvlc vlc-plugin-a52 vlc-plugin-ogg vlc-plugin-mad
```

3.1.6. Linux Redhat

Download the RPM package *vlc* and the packages listed in the *required libraries and codecs* section (the other packages are just optional) from the [VLC Red Hat download page](#) and put them all into the same directory.

Then install the RPM packages you have downloaded:

```
# rpm -U *.rpm
```

If you have not installed all the RPM packages included with your distribution, you may be asked to install a few of them first.

3.1.7. Compile the sources by yourself (for every other OS)

The method below is for any Unix system supported by VLC, for which there is no packages available. It explains how to compile and install VLC and the needed libraries from their source code.

You can also compile VLC under Linux this way if you want to modify the default supported modules.

3.1.7.1. Install the libraries

Many libraries are needed :

- *libdvbpsi* (compulsory) ,
- *mpeg2dec* (compulsory) ,
- *libdvdcss* if you want to be able to read encrypted DVDs ,
- *libdvdplay* if you want to have DVD menu navigation ,
- *a52dec* if you want to be able to decode the AC3 (i.e. A52) sound format often used in DVDs ,
- *ffmpeg*, *libmad*, *faad2* if you want to read MPEG 4 / DivX files ,
- *libogg* & *libvorbis* if you want to read Ogg Vorbis files .

Download the libraries from the [VLC sources download page](#).

For each library :

- uncompress :

```
% tar xvzf library.tar.gz
```

or

```
% tar xvjf library.tar.bz2
```

- configure :

```
% cd library
% ./configure
```

- compile and install :

```
% make
# make install
```

Check that the configuration file `/etc/ld.so.conf` contains the following line :

```
/usr/local/lib
```

If the line is not present, add-it and then run (as root):

```
# ldconfig
```

3.1.7.2. Install VLC

Download the sources of the latest release : get the file `vlc-version.tar.gz` from the [VLC sources download page](#). Uncompress-it :

```
% tar xvzf vlc-version.tar.gz
% cd vlc-version
```

To get the list of configuration options, do :

```
% ./configure --help
```

Please note that all the modules are described in the *Modules* section of the [VLC User Guide](#) .

Examples of very simple configurations:

- if you want a basic VLC, do :

```
% ./configure
```

- if you want the Gnome interface instead of the GTK interface (you will need the development packages of Gnome) :

```
% ./configure --enable-gnome
```

Then, compile and install :

```
% make
% su
Password: [Root Password]
```

```
# make install
```

Please note that the installation (**make install** command) is not mandatory. You can execute VLC from where you compiled it.

3.2. Uninstalling VLC

3.2.1. Windows

Click on the *Uninstall VLC* icon that was created during installation .

3.2.2. BeOS

Delete the `vlc-version` directory. You can also remove the configuration file `/boot/home/config/settings/vlcrc` .

3.2.3. Mac OS X

Drag the VLC application to your trash can .

3.2.4. Debian GNU/Linux

Remove the packages that you installed :

```
# apt-get remove --purge vlc-gnome vlc-mad libdvdcss2 libdvbpsi1
```

3.2.5. GNU/Linux Redhat, Mandrake and SuSE

Uninstall the RPM packages that you installed :

```
# rpm -e vlc-version vlc-mad-version vlc-gnome-version  
libdvdcss2-version libdvbpsi1-version
```

3.2.6. If you compiled VLC from sources

Go to the directory containing VLC sources and execute :

```
# make uninstall
```

Then you can remove the VLC sources .

Chapter 4. The command line interface

4.1. Introduction

Many options are only available through command line. They are detailed here .

4.2. Opening streams

The following commands start VLC and add the first element to the playlist .

4.2.1. Opening a file

Start VLC with :

```
% vlc -vvv my_file.mpg
```

Although VLC should be able to recognize the file type, you may tell VLC what codec to use with the `--codec` option. For example to play `my_file.mpg` using `ffmpeg` audio/video decoder do :

```
% vlc -vvv --codec ffmpeg my_file.mpg
```

A list of all video and audio codecs supported by VLC is available on the [VLC features list](#) .

4.2.2. Opening a DVD or VCD, or an audio CD

Start VLC with

```
% vlc -vvv dvd:[device][@raw_device][@[title][,[chapter][,angle]]]
```

or (VCD):

```
% vlc -vvv vcd:[device][@[title][,[chapter][peripherique][@[titre][,chapitre]]]
```

or (Audio CD):

```
% vlc -vvv cdda:[device][@[title]][peripherique][@[titre]]
```

where `device` is the complete path to your DVD or CD-ROM drive .

4.2.3. Start a network stream

To receive an unicast UDP stream (sent by VLS or VLC's stream output), start VLC with :

```
% vlc -vvv udp:[@:server_port]
```

To receive an multicast UDP stream (sent by VLS or VLC's stream output), start VLC with :

```
% vlc -vvv udp:@multicast_address[:server_port]
```

To receive a HTTP stream, start VLC with :

```
% vlc -vvv http://www.example.org/your_file.mpg
```

4.3. Modules selection

VLC tries to select the most appropriate interface, input and output modules, among the ones available on the system, according to the stream it is given to read. However, you may wish to force the use of a specific module with the following options (for the complete list of modules, see the [Modules and options for VLC](#) section) :

- `--intf <module>` allows you to select the interface module .
- `--extraintf <module>` allows you to select extra interface modules that will be launched in addition to the main one .
- `--aout <module>` allows you to select the audio output module .
- `--vout <module>` allows you to select the video output module .
- `--filter <module>` allows you to add a video filter module .
- `--mempcy <module>` allows you to choose a memory copy module .

4.4. Stream Output

4.4.1. Description of the stream output

VLC's stream output allows VLC to be used as a streaming server instead of a client ! It has very extended capabilities :

- stream in unicast and multicast on an IPv4 or IPv6 network everything that VLC is able to read, via UDP, RTP or HTTP ;
- save the input stream to a file in AVI, PS, TS or OGG format ;
- transcode an input stream, and then, send it, to the network or to a file .

To know about the full possibilities of VLC's stream output, see the [streaming features page](#) .

4.4.2. Architecture and syntax

the stream output has a powerful architecture that uses modules. Each module has capabilities, and you can *chain* the modules to enhance the possibilities .

Here is the list of the modules currently available :

- *standard* "sends" the stream via an *access output* module: for example, UDP, file, HTTP, ... You will probably want to use this module at the end of your chains .
- *transcode* allows you to transcode the audio and the video of the input stream "on the fly" (if your computer is powerful enough) .
- *duplicate* allows you to create a second chain, where the stream will be handled in an independant way .

- *display* allows you to display the input stream, as VLC would normally do. Used with the *duplicate* module, this allows you to view the stream as you send it .
- *es* allows you to make separate Elementary Estreams (ES) out of an input stream .

Each of these modules may take options. Here is the syntax that you must use :

```
% vlc input_stream --sout '#module1{option1=...,option2=...}:#module2{option1=...,option2=...}:'
```

For example, to transcode a stream and send it, use :

```
% vlc input_stream --sout '#transcode{options}:#standard{options}'
```

4.4.3. Description of the modules

4.4.3.1. standard (alias std)

Sends a stream .

Options:

- *access*: how to send : *file*, *udp*, *rtp*, *http*.
- *mux*: which muxer (ie, which format) will be used. It can be one of *avi* (for AVI format) , *ogg* (for OGG format) , *ps* (for MPEG2–PS format) , *ts* (for MPEG2–TS format) .
- *url*: if you use the *file* access, it will be the location where to store the stream; if you use another access, it will be the unicast or multicast IP address where you want to stream .
- *sap*: if you use the *udp* or *rtp* accesses, use this option to announce your stream, using SAP/SDP. This option contains the name under which you want to announce the program .
- *slp*: like *sap*, but use the SLP protocol. You need to have libslp on your system .
- *sap_ipv*: if you use the *sap* option, use this option to specify if you want to send the SAP announces in IPv4 or IPv6. The value of this option is *4* or *6* si vous utilisez *sap*, utilisez ceci pour spécifier si vous désirez envoyer les annonces SAP en IPv4 –défaut– ou IPv6. La valeur à utiliser est *4* ou *6* .



If you are streaming in multicast, you may want to use the global option `--ttl 12` to set the TTL to a value superior to 1.

4.4.3.2. display

Displays the stream .

Options:

- *noaudio*: Ignore audio .
- *novideo*: Ignore video .

4.4.3.3. duplicate

Duplicates the stream to a new stream output chain .

Options:

- *dst*: A new stream output chain of modules, as described earlier .
-

4.4.3.4. transcode

Changes the codec and/or bitrates for a stream .

Options:

- *acodec*: the new audio codec. It can be one of *mpga* (MPEG audio layer 2), *a52* or *ac3* (AC3 sound) or *vorb* (Vorbis)
 - *ab*: audio bitrate in Kbps .
 - *vcodec*: the new video codec. It can be one of *mp4v* (MPEG4), *mpgv* (MPEG1), *DIV1*, *DIV2*, *DIV3* (DivX 1,2,3), *H263* (H263), *I263* (H263I), *WMV1* or *WMV2* (Windows Media Video 1 or 2), *MJPG* (MJPEG), *MJPB* (MJPEGB) .
 - *width*: video width .
 - *height*: video height .
 - *vb*: video bitrate in kbps .
 - *vt*: video bitrate tolerance in bps .
 - *deinterlace*: deinterlace the stream .
 - *croptop*: number of pixels removed from the top of the video .
 - *cropbottom*: number of pixel removed from the bottom of the video .
 - *cropleft*: number of pixels removed from the left of the video .
 - *cropright*: number of pixels removed from the right of the video .
 - *hq*: high quality transcoding (uses more CPU) .
 - *qmin*: minimum video quantiser scale (VBR)
 - *qmax*: maximum video quantiser scale (VBR) .
-

4.4.3.5. es

Make separate Elementary Streams .

Options:

- *access_audio*: how to send the audio track: *file*, *udp*, *rtp* or *http* .
- *access_video*: how to send the video track: *file*, *udp*, *rtp* or *http* .
- *access*: if you want the audio and the video tracks to use the same access, use this option instead of the two above .
- *mux_audio*: which muxer (ie, which format) will be used for the audio track. It can be one of *avi* (for AVI format), *ogg* (for OGG format), *ps* (for MPEG2–PS format), *ts* (for MPEG2–TS format) .
- *mux_video*: which muxer (ie, which format) will be used for the video track. It can be one of *avi* (for AVI format), *ogg* (for OGG format), *ps* (for MPEG2–PS format), *ts* (for MPEG2–TS format) .
- *mux*: if you want the audio and the video tracks to use the same muxer, use this option instead of the two above .
- *url_audio*: if you use the *file* access, it will be the location where to store the audio track; if you use another access, it will be the unicast or multicast IP address where you want to stream .
- *url_video*: if you use the *file* access, it will be the location where to store the video track; if you use another access, it will be the unicast or multicast IP address where you want to stream .
- *url*: if you want the audio and the video tracks to use the same url, use this option instead of the two above .

 In the *url* options, if you use the *file* access, you can use the following macros in the filename:

- *%n* = stream number ;
- *%c* = FOURCC ;
- *%m* = muxer ;
- *%a* = access.

4.4.3.6. Miscellaneous

Here are a few additional global options

- *--no-sout-audio* disables audio stream output .
- *--no-sout-video* disables video stream output .

The stream output also offers a simplified syntax, with which you can only you use the *standard* module main options :

```
% vlc input_stream --sout access/mux:url
```

where *access*, *mux* and *url* are as defined in the options of the standard module .

4.4.4. Examples

To understand fully the complex syntax of VLC's stream output, please look at the use cases of the VideoLAN HOWTO .

4.5. Other Options

4.5.1. Audio options

- *--noaudio* disables audio output .
- *--mono* forces VLC to treat the stream in mono audio .
- *--volume <integer>* sets the level of audio output .
- *--aout-rate <integer>* sets the audio output frequency (Hz) .
- *--desync <integer>* compensates desynchronization of audio (ms) .
- *--headphone* activates headphone virtual spatialization effect .
- *--headphone-dim* sets headphone characteristic dimension .

4.5.2. Video options

- *--novideo* disables video output .
- *--greyscale* turns video output into greyscale mode .
- *--fullscreen* sets fullscreen video .
- *--nooverlay* disables hardware acceleration for the video output .
- *--width, --height <integer>* sets the video window dimensions .
- *--zoom <float>* adds a zoom factor .
- *--aspect-ratio <mode>* forces source aspect ratio .
- *--spumargin <integer>* forces SPU subtitles postion .

4.5.3. Playlist options

- `--playlist` launches playlist on startup .
 - `--random` plays files randomly forever .
 - `--enqueue` enqueues items in playlist .
 - `--loop` loops playlist on end .
-

4.5.4. Network options

- `--server-port <integer>` sets server port .
 - `--iface <string>` specifies the network interface to use .
 - `--iface-addr <string>` specifies your network interface IP address .
 - `--mtu <integer>` specifies the MTU of the network interface .
 - `--ipv6` forces IPv6 .
 - `--ipv4` forces IPv4 .
-

4.5.5. CPU options

- `--nommx` disables the use of MMX CPU extensions .
 - `--no3dn` disables the use of 3D Now! CPU extensions .
 - `--nommnext` disables the use of MMX Ext CPU extensions .
 - `--nosse` disables the use of SSE CPU extensions .
-

4.5.6. Miscellaneous options

- `--quiet` be quiet .
 - `--color` displays color messages .
 - `--search-path <string>` specifies interface default search path .
 - `--plugin-path <string>` specifies plugin search path .
 - `--dvd <string>` specifies the default VCD device .
 - `--vcd <string>` specifies the default VCD device .
 - `--program <integer>` specifies program (SID) (for streams with several programs, like satellite ones) .
 - `--audio-type <integer>` specifies the default audio type to use with dvds .
 - `--audio-channel <integer>` specifies the default audio channel to use with dvds .
 - `--spu-channel <integer>` specifies the default subtitle channel to use with dvds .
-

4.5.7. Help options

- `--verbose <verbosity>` specifies verbosity level .
 - `--help` gives you all available options .
 - `--longhelp` gives you a detailed version of the available options .
 - `--version` gives you information about the current VLC version .
 - `--list` displays a list of available plugins .
 - `--module <module>` displays help about specified module .
-

Chapter 5. The Mozilla plugin

VLC can also be embedded in a web browser ! For the moment, this function is only available with Mozilla under GNU/Linux .

5.1. Install the plugin

5.1.1. GNU/Linux Debian

You should already have the following lines in your `/etc/apt/sources.list` file :

```
deb http://www.videolan.org/pub/videolan/debian $(ARCH)/
deb-src http://www.videolan.org/pub/videolan/debian sources/
```

Install the `mozilla-plugin-vlc` package :

```
# apt-get update
# apt-get install mozilla-plugin-vlc
```

5.1.2. Compile the sources yourself

Install the Mozilla development package (`mozilla-dev` under Debian) .

Install the required libraries like for a normal VLC install (from the sources, or from the packages with the development packages).

Download the sources of the lastest release : get the file `vlc-version.tar.gz` from the [VLC sources download page](#). Uncompress-it, configure-it, compile and install Téléchargez les sources de la dernière version : récupérez le fichier `vlc-version.tar.gz` depuis la [page de téléchargement des sources de VLC](#). Décompressez-le, configurez-le, compilez et installez :

```
% tar xvzf vlc-version.tar.gz
% cd vlc-version
% ./configure --enable-mozilla
% make
% su
Password: [Root Password]
# make install
```

5.2. Build HTML pages that use the plugin

Here are a few examples of HTML pages that use the Mozilla plugin .

5.2.1. Example 1

In this example, the plugin will read an HTTP stream inside the web page. If the user goes fullscreen, he will have to press `f` to go back in normal view .

```
<html>
```

VLC user guide

```
<head><title>Demo of VLC mozilla plugin</title></head>

<body>

<h1>Demo of VLC mozilla plugin - Example 1</h1>

<embed type="application/x-vlc-plugin"
        name="video1"
        autoplay="no" loop="yes" width="400" height="300"
        target="http://server.example.org/video1.vob" />
<br />
  <a href="javascript:;" onclick='document.video1.play()>Play video1</a>
  <a href="javascript:;" onclick='document.video1.pause()>Pause video1</a>
  <a href="javascript:;" onclick='document.video1.stop()>Stop video1</a>
  <a href="javascript:;" onclick='document.video1.fullscreen()>Fullscreen</a>

</body>
</html>
```

5.2.2. Example 2

In this example, the plugin will read a multicast UDP stream in a dedicated video output window .

```
<html>
<head><title>Demo of VLC mozilla plugin</title></head>

<body>

<h1>Demo of VLC mozilla plugin - Example 2</h1>

<embed type="application/x-vlc-plugin"
        name="video2"
        autoplay="no" loop="no" hidden="yes"
        target="udp:@239.255.12.42" />
<br />
  <a href="javascript:;" onclick='document.video2.play()>Play video2</a>
  <a href="javascript:;" onclick='document.video2.stop()>Stop video2</a>
  <a href="javascript:;" onclick='document.video2.fullscreen()>Fullscreen</a>

</body>
</html>
```

Appendix A. GNU Free Documentation License

Version 1.2, November 2002

Copyright (C) 2000,2001,2002 Free Software Foundation, Inc. 59 Temple Place, Suite 330, Boston, MA 02111-1307 USA Everyone is permitted to copy and distribute verbatim copies of this license document, but changing it is not allowed.

A.1. PREAMBLE

The purpose of this License is to make a manual, textbook, or other functional and useful document "free" in the sense of freedom: to assure everyone the effective freedom to copy and redistribute it, with or without modifying it, either commercially or noncommercially. Secondly, this License preserves for the author and publisher a way to get credit for their work, while not being considered responsible for modifications made by others.

This License is a kind of "copyleft", which means that derivative works of the document must themselves be free in the same sense. It complements the GNU General Public License, which is a copyleft license designed for free software.

We have designed this License in order to use it for manuals for free software, because free software needs free documentation: a free program should come with manuals providing the same freedoms that the software does. But this License is not limited to software manuals; it can be used for any textual work, regardless of subject matter or whether it is published as a printed book. We recommend this License principally for works whose purpose is instruction or reference.

A.2. APPLICABILITY AND DEFINITIONS

This License applies to any manual or other work, in any medium, that contains a notice placed by the copyright holder saying it can be distributed under the terms of this License. Such a notice grants a world-wide, royalty-free license, unlimited in duration, to use that work under the conditions stated herein. The "Document", below, refers to any such manual or work. Any member of the public is a licensee, and is addressed as "you". You accept the license if you copy, modify or distribute the work in a way requiring permission under copyright law.

A "Modified Version" of the Document means any work containing the Document or a portion of it, either copied verbatim, or with modifications and/or translated into another language.

A "Secondary Section" is a named appendix or a front-matter section of the Document that deals exclusively with the relationship of the publishers or authors of the Document to the Document's overall subject (or to related matters) and contains nothing that could fall directly within that overall subject. (Thus, if the Document is in part a textbook of mathematics, a Secondary Section may not explain any mathematics.) The relationship could be a matter of historical connection with the subject or with related matters, or of legal, commercial, philosophical, ethical or political position regarding them.

The "Invariant Sections" are certain Secondary Sections whose titles are designated, as being those of Invariant Sections, in the notice that says that the Document is released under this License. If a section does not fit the above definition of Secondary then it is not allowed to be designated as Invariant. The Document

may contain zero Invariant Sections. If the Document does not identify any Invariant Sections then there are none.

The "Cover Texts" are certain short passages of text that are listed, as Front–Cover Texts or Back–Cover Texts, in the notice that says that the Document is released under this License. A Front–Cover Text may be at most 5 words, and a Back–Cover Text may be at most 25 words.

A "Transparent" copy of the Document means a machine–readable copy, represented in a format whose specification is available to the general public, that is suitable for revising the document straightforwardly with generic text editors or (for images composed of pixels) generic paint programs or (for drawings) some widely available drawing editor, and that is suitable for input to text formatters or for automatic translation to a variety of formats suitable for input to text formatters. A copy made in an otherwise Transparent file format whose markup, or absence of markup, has been arranged to thwart or discourage subsequent modification by readers is not Transparent. An image format is not Transparent if used for any substantial amount of text. A copy that is not "Transparent" is called "Opaque".

Examples of suitable formats for Transparent copies include plain ASCII without markup, Texinfo input format, LaTeX input format, SGML or XML using a publicly available DTD, and standard–conforming simple HTML, PostScript or PDF designed for human modification. Examples of transparent image formats include PNG, XCF and JPG. Opaque formats include proprietary formats that can be read and edited only by proprietary word processors, SGML or XML for which the DTD and/or processing tools are not generally available, and the machine–generated HTML, PostScript or PDF produced by some word processors for output purposes only.

The "Title Page" means, for a printed book, the title page itself, plus such following pages as are needed to hold, legibly, the material this License requires to appear in the title page. For works in formats which do not have any title page as such, "Title Page" means the text near the most prominent appearance of the work's title, preceding the beginning of the body of the text.

A section "Entitled XYZ" means a named subunit of the Document whose title either is precisely XYZ or contains XYZ in parentheses following text that translates XYZ in another language. (Here XYZ stands for a specific section name mentioned below, such as "Acknowledgements", "Dedications", "Endorsements", or "History".) To "Preserve the Title" of such a section when you modify the Document means that it remains a section "Entitled XYZ" according to this definition.

The Document may include Warranty Disclaimers next to the notice which states that this License applies to the Document. These Warranty Disclaimers are considered to be included by reference in this License, but only as regards disclaiming warranties: any other implication that these Warranty Disclaimers may have is void and has no effect on the meaning of this License.

A.3. VERBATIM COPYING

You may copy and distribute the Document in any medium, either commercially or noncommercially, provided that this License, the copyright notices, and the license notice saying this License applies to the Document are reproduced in all copies, and that you add no other conditions whatsoever to those of this License. You may not use technical measures to obstruct or control the reading or further copying of the copies you make or distribute. However, you may accept compensation in exchange for copies. If you distribute a large enough number of copies you must also follow the conditions in section 3.

You may also lend copies, under the same conditions stated above, and you may publicly display copies.

A.4. COPYING IN QUANTITY

If you publish printed copies (or copies in media that commonly have printed covers) of the Document, numbering more than 100, and the Document's license notice requires Cover Texts, you must enclose the copies in covers that carry, clearly and legibly, all these Cover Texts: Front–Cover Texts on the front cover, and Back–Cover Texts on the back cover. Both covers must also clearly and legibly identify you as the publisher of these copies. The front cover must present the full title with all words of the title equally prominent and visible. You may add other material on the covers in addition. Copying with changes limited to the covers, as long as they preserve the title of the Document and satisfy these conditions, can be treated as verbatim copying in other respects.

If the required texts for either cover are too voluminous to fit legibly, you should put the first ones listed (as many as fit reasonably) on the actual cover, and continue the rest onto adjacent pages.

If you publish or distribute Opaque copies of the Document numbering more than 100, you must either include a machine–readable Transparent copy along with each Opaque copy, or state in or with each Opaque copy a computer–network location from which the general network–using public has access to download using public–standard network protocols a complete Transparent copy of the Document, free of added material. If you use the latter option, you must take reasonably prudent steps, when you begin distribution of Opaque copies in quantity, to ensure that this Transparent copy will remain thus accessible at the stated location until at least one year after the last time you distribute an Opaque copy (directly or through your agents or retailers) of that edition to the public.

It is requested, but not required, that you contact the authors of the Document well before redistributing any large number of copies, to give them a chance to provide you with an updated version of the Document.

A.5. MODIFICATIONS

You may copy and distribute a Modified Version of the Document under the conditions of sections 2 and 3 above, provided that you release the Modified Version under precisely this License, with the Modified Version filling the role of the Document, thus licensing distribution and modification of the Modified Version to whoever possesses a copy of it. In addition, you must do these things in the Modified Version:

- A. Use in the Title Page (and on the covers, if any) a title distinct from that of the Document, and from those of previous versions (which should, if there were any, be listed in the History section of the Document). You may use the same title as a previous version if the original publisher of that version gives permission.
- B. List on the Title Page, as authors, one or more persons or entities responsible for authorship of the modifications in the Modified Version, together with at least five of the principal authors of the Document (all of its principal authors, if it has fewer than five), unless they release you from this requirement.
- C. State on the Title page the name of the publisher of the Modified Version, as the publisher.
- D. Preserve all the copyright notices of the Document.
- E. Add an appropriate copyright notice for your modifications adjacent to the other copyright notices.
- F. Include, immediately after the copyright notices, a license notice giving the public permission to use the Modified Version under the terms of this License, in the form shown in the [Addendum](#) below.
- G. Preserve in that license notice the full lists of Invariant Sections and required Cover Texts given in the Document's license notice.

- H. Include an unaltered copy of this License.
- I. Preserve the section Entitled "History", Preserve its Title, and add to it an item stating at least the title, year, new authors, and publisher of the Modified Version as given on the Title Page. If there is no section Entitled "History" in the Document, create one stating the title, year, authors, and publisher of the Document as given on its Title Page, then add an item describing the Modified Version as stated in the previous sentence.
- J. Preserve the network location, if any, given in the Document for public access to a Transparent copy of the Document, and likewise the network locations given in the Document for previous versions it was based on. These may be placed in the "History" section. You may omit a network location for a work that was published at least four years before the Document itself, or if the original publisher of the version it refers to gives permission.
- K. For any section Entitled "Acknowledgements" or "Dedications", Preserve the Title of the section, and preserve in the section all the substance and tone of each of the contributor acknowledgements and/or dedications given therein.
- L. Preserve all the Invariant Sections of the Document, unaltered in their text and in their titles. Section numbers or the equivalent are not considered part of the section titles.
- M. Delete any section Entitled "Endorsements". Such a section may not be included in the Modified Version.
- N. Do not retitle any existing section to be Entitled "Endorsements" or to conflict in title with any Invariant Section.
- O. Preserve any Warranty Disclaimers.

If the Modified Version includes new front-matter sections or appendices that qualify as Secondary Sections and contain no material copied from the Document, you may at your option designate some or all of these sections as invariant. To do this, add their titles to the list of Invariant Sections in the Modified Version's license notice. These titles must be distinct from any other section titles.

You may add a section Entitled "Endorsements", provided it contains nothing but endorsements of your Modified Version by various parties—for example, statements of peer review or that the text has been approved by an organization as the authoritative definition of a standard.

You may add a passage of up to five words as a Front-Cover Text, and a passage of up to 25 words as a Back-Cover Text, to the end of the list of Cover Texts in the Modified Version. Only one passage of Front-Cover Text and one of Back-Cover Text may be added by (or through arrangements made by) any one entity. If the Document already includes a cover text for the same cover, previously added by you or by arrangement made by the same entity you are acting on behalf of, you may not add another; but you may replace the old one, on explicit permission from the previous publisher that added the old one.

The author(s) and publisher(s) of the Document do not by this License give permission to use their names for publicity for or to assert or imply endorsement of any Modified Version.

A.6. COMBINING DOCUMENTS

You may combine the Document with other documents released under this License, under the terms defined in [section 4](#) above for modified versions, provided that you include in the combination all of the Invariant Sections of all of the original documents, unmodified, and list them all as Invariant Sections of your combined work in its license notice, and that you preserve all their Warranty Disclaimers.

The combined work need only contain one copy of this License, and multiple identical Invariant Sections may be replaced with a single copy. If there are multiple Invariant Sections with the same name but different

contents, make the title of each such section unique by adding at the end of it, in parentheses, the name of the original author or publisher of that section if known, or else a unique number. Make the same adjustment to the section titles in the list of Invariant Sections in the license notice of the combined work.

In the combination, you must combine any sections Entitled "History" in the various original documents, forming one section Entitled "History"; likewise combine any sections Entitled "Acknowledgements", and any sections Entitled "Dedications". You must delete all sections Entitled "Endorsements".

A.7. COLLECTIONS OF DOCUMENTS

You may make a collection consisting of the Document and other documents released under this License, and replace the individual copies of this License in the various documents with a single copy that is included in the collection, provided that you follow the rules of this License for verbatim copying of each of the documents in all other respects.

You may extract a single document from such a collection, and distribute it individually under this License, provided you insert a copy of this License into the extracted document, and follow this License in all other respects regarding verbatim copying of that document.

A.8. AGGREGATION WITH INDEPENDENT WORKS

A compilation of the Document or its derivatives with other separate and independent documents or works, in or on a volume of a storage or distribution medium, is called an "aggregate" if the copyright resulting from the compilation is not used to limit the legal rights of the compilation's users beyond what the individual works permit. When the Document is included in an aggregate, this License does not apply to the other works in the aggregate which are not themselves derivative works of the Document.

If the Cover Text requirement of section 3 is applicable to these copies of the Document, then if the Document is less than one half of the entire aggregate, the Document's Cover Texts may be placed on covers that bracket the Document within the aggregate, or the electronic equivalent of covers if the Document is in electronic form. Otherwise they must appear on printed covers that bracket the whole aggregate.

A.9. TRANSLATION

Translation is considered a kind of modification, so you may distribute translations of the Document under the terms of section 4. Replacing Invariant Sections with translations requires special permission from their copyright holders, but you may include translations of some or all Invariant Sections in addition to the original versions of these Invariant Sections. You may include a translation of this License, and all the license notices in the Document, and any Warranty Disclaimers, provided that you also include the original English version of this License and the original versions of those notices and disclaimers. In case of a disagreement between the translation and the original version of this License or a notice or disclaimer, the original version will prevail.

If a section in the Document is Entitled "Acknowledgements", "Dedications", or "History", the requirement (section 4) to Preserve its Title (section 1) will typically require changing the actual title.

A.10. TERMINATION

You may not copy, modify, sublicense, or distribute the Document except as expressly provided for under this License. Any other attempt to copy, modify, sublicense or distribute the Document is void, and will automatically terminate your rights under this License. However, parties who have received copies, or rights, from you under this License will not have their licenses terminated so long as such parties remain in full compliance.

A.11. FUTURE REVISIONS OF THIS LICENSE

The Free Software Foundation may publish new, revised versions of the GNU Free Documentation License from time to time. Such new versions will be similar in spirit to the present version, but may differ in detail to address new problems or concerns. See <http://www.gnu.org/copyleft/>.

Each version of the License is given a distinguishing version number. If the Document specifies that a particular numbered version of this License "or any later version" applies to it, you have the option of following the terms and conditions either of that specified version or of any later version that has been published (not as a draft) by the Free Software Foundation. If the Document does not specify a version number of this License, you may choose any version ever published (not as a draft) by the Free Software Foundation.

A.12. ADDENDUM: How to use this License for your documents

To use this License in a document you have written, include a copy of the License in the document and put the following copyright and license notices just after the title page:

Copyright (c) YEAR YOUR NAME. Permission is granted to copy, distribute and/or modify this document under the terms of the GNU Free Documentation License, Version 1.2 or any later version published by the Free Software Foundation; with no Invariant Sections, no Front-Cover Texts, and no Back-Cover Texts. A copy of the license is included in the section entitled "GNU Free Documentation License".

If you have Invariant Sections, Front-Cover Texts and Back-Cover Texts, replace the "with...Texts." line with this:

with the Invariant Sections being LIST THEIR TITLES, with the Front-Cover Texts being LIST, and with the Back-Cover Texts being LIST.

If you have Invariant Sections without Cover Texts, or some other combination of the three, merge those two alternatives to suit the situation.

If your document contains nontrivial examples of program code, we recommend releasing these examples in parallel under your choice of free software license, such as the GNU General Public License, to permit their use in free software.