

Internet Engineering Task Force (IETF)
Request for Comments: 5844
Category: Standards Track
ISSN: 2070-1721

R. Wakikawa
Toyota ITC
S. Gundavelli
Cisco
May 2010

IPv4 Support for Proxy Mobile IPv6

Abstract

This document specifies extensions to the Proxy Mobile IPv6 protocol for adding IPv4 protocol support. The scope of IPv4 protocol support is two-fold: 1) enable IPv4 home address mobility support to the mobile node, and 2) allow the mobility entities in the Proxy Mobile IPv6 domain to exchange signaling messages over an IPv4 transport network.

Status of This Memo

This is an Internet Standards Track document.

This document is a product of the Internet Engineering Task Force (IETF). It represents the consensus of the IETF community. It has received public review and has been approved for publication by the Internet Engineering Steering Group (IESG). Further information on Internet Standards is available in Section 2 of RFC 5741.

Information about the current status of this document, any errata, and how to provide feedback on it may be obtained at <http://www.rfc-editor.org/info/rfc5844>.

Copyright Notice

Copyright (c) 2010 IETF Trust and the persons identified as the document authors. All rights reserved.

This document is subject to BCP 78 and the IETF Trust's Legal Provisions Relating to IETF Documents (<http://trustee.ietf.org/license-info>) in effect on the date of publication of this document. Please review these documents carefully, as they describe your rights and restrictions with respect to this document. Code Components extracted from this document must include Simplified BSD License text as described in Section 4.e of the Trust Legal Provisions and are provided without warranty as described in the Simplified BSD License.

Table of Contents

1.	Overview	3
1.1.	Stated Assumptions	4
1.2.	Relevance to Dual-Stack Mobile IPv6	5
2.	Conventions and Terminology	6
2.1.	Conventions	6
2.2.	Terminology	6
3.	IPv4 Home Address Mobility Support	8
3.1.	Local Mobility Anchor Considerations	9
3.1.1.	Extensions to Binding Cache Entry	9
3.1.2.	Signaling Considerations	10
3.1.3.	Routing Considerations for the Local Mobility Anchor	15
3.1.4.	ECN and Payload Fragmentation Considerations	16
3.2.	Mobile Access Gateway Considerations	17
3.2.1.	Extensions to Binding Update List Entry	17
3.2.2.	Extensions to Mobile Node's Policy Profile	17
3.2.3.	Signaling Considerations	17
3.2.4.	Routing Considerations for the Mobile Access Gateway	21
3.3.	Mobility Options and Status Codes	22
3.3.1.	IPv4 Home Address Request Option	22
3.3.2.	IPv4 Home Address Reply Option	23
3.3.3.	IPv4 Default-Router Address Option	25
3.3.4.	IPv4 DHCP Support Mode Option	25
3.3.5.	Status Codes	26
3.4.	Supporting DHCP-Based Address Configuration	27
3.4.1.	DHCP Server Co-Located with the Mobile Access Gateway	28
3.4.2.	DHCP Relay Agent Co-Located with the Mobile Access Gateway	31
3.4.3.	Common DHCP Considerations	33
4.	IPv4 Transport Support	35
4.1.	Local Mobility Anchor Considerations	37
4.1.1.	Extensions to Binding Cache Entry	37
4.1.2.	Extensions to Mobile Node's Policy Profile	37
4.1.3.	Signaling Considerations	37
4.1.4.	Routing Considerations	39
4.2.	Mobile Access Gateway Considerations	40
4.2.1.	Extensions to Binding Update List Entry	40
4.2.2.	Signaling Considerations	40
4.3.	IPsec Considerations	43
4.3.1.	PBU and PBA	43
4.3.2.	Payload Packet	43
5.	Protocol Configuration Variables	44
5.1.	Local Mobility Anchor - Configuration Variables	44
5.2.	Mobile Access Gateway - Configuration Variables	44

6. IANA Considerations	45
7. Security Considerations	46
8. Contributors	46
9. Acknowledgements	47
10. References	47
10.1. Normative References	47
10.2. Informative References	48

1. Overview

The transition from IPv4 to IPv6 is a long process, and during this period of transition, both the protocols will be enabled over the same network infrastructure. Thus, it is reasonable to assume that a mobile node in a Proxy Mobile IPv6 domain may operate in an IPv4-only, IPv6-only, or dual-stack mode, and the network between the mobile access gateway and a local mobility anchor may be an IPv4 or an IPv6 network. It is also reasonable to expect the same mobility infrastructure in the Proxy Mobile IPv6 domain to provide mobility to the mobile nodes operating in IPv4, IPv6, or in dual mode and whether the transport network is IPv4 or IPv6 network. The motivation and scope of IPv4 support in Mobile IPv6 is summarized in [RFC4977], and all those requirements apply to Proxy Mobile IPv6 protocol as well.

The Proxy Mobile IPv6 protocol [RFC5213] specifies a mechanism for providing IPv6 home address mobility support to a mobile node in a Proxy Mobile IPv6 domain. The protocol requires IPv6 transport network between the mobility entities. The extensions defined in this document specify IPv4 support to the Proxy Mobile IPv6 protocol [RFC5213].

The scope of IPv4 support in Proxy Mobile IPv6 includes the support for the following two features:

- o IPv4 Home Address Mobility Support: A mobile node that is dual-stack or IPv4-only enabled will be able to obtain an IPv4 address and be able to use that address from any of the access networks in that Proxy Mobile IPv6 domain. The mobile node is not required to be allocated or assigned an IPv6 address to enable IPv4 home address support.
- o IPv4 Transport Network Support: The mobility entities in the Proxy Mobile IPv6 domain will be able to exchange Proxy Mobile IPv6 signaling messages over an IPv4 transport.

These two features, the IPv4 home address mobility support and the IPv4 transport support features, are independent of each other, and deployments may choose to enable either one or both of these features as required.

Figure 1 shows a typical Proxy Mobile IPv6 domain with an IPv4 transport network and with IPv4 enabled mobile nodes. The terms used in this illustration are explained in the Terminology section.

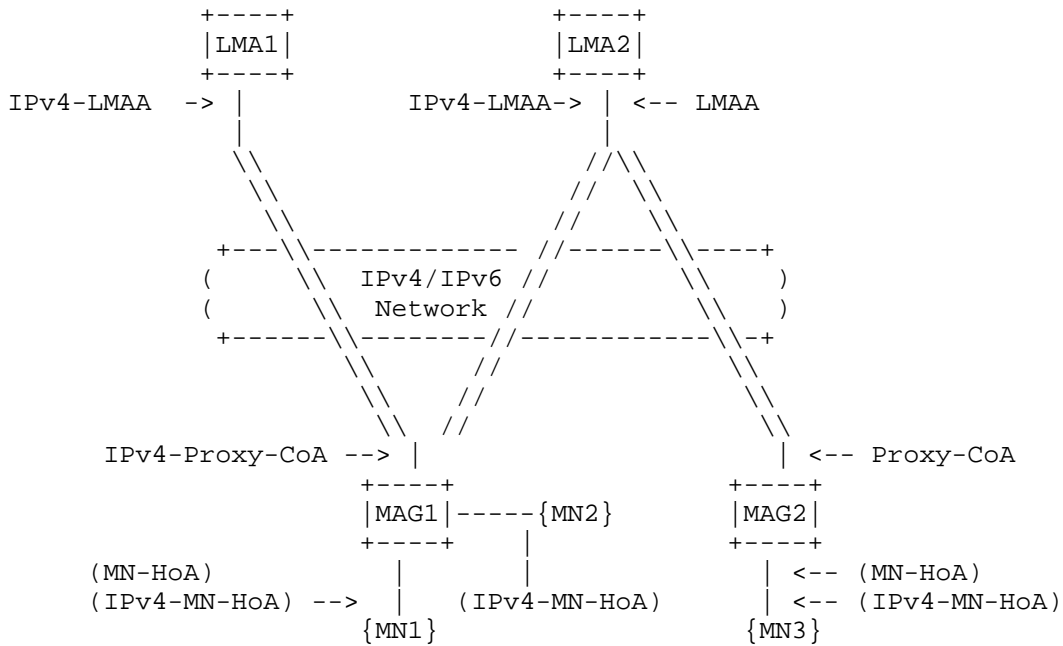

Figure 1: IPv4 Support for Proxy Mobile IPv6

1.1. Stated Assumptions

The following are the system and configuration requirements from the mobility entities in the Proxy Mobile IPv6 domain for supporting the extensions defined in this document.

- o Both the mobility entities, the local mobility anchor and the mobile access gateway are dual-stack (IPv4/IPv6) enabled. Irrespective of the type of transport network (IPv4 or IPv6) separating these two entities, the mobility signaling is always based on Proxy Mobile IPv6 protocol [RFC5213].
- o A deployment where a mobile access gateway uses an IPv4 private address with NAT [RFC3022] translation devices in the path to a local mobility anchor is not supported by this specification.

- o The mobile node can be operating in IPv4-only, IPv6-only or in dual mode. Based on the enabled configuration for a mobile node, the mobile node should be able to obtain IPv4-only, IPv6-only, or both IPv4 and IPv6 addresses for its interface and furthermore achieve mobility support for those addresses.
- o For enabling IPv4 home address mobility support to a mobile node, it is not required that the IPv6 home address mobility support need be enabled. However, the respective protocol(s) support, such as IPv4 or IPv6 packet forwarding, must be enabled on the access link between the mobile node and the mobile access gateway.
- o The mobile node can obtain an IPv4 address for its attached interface. Based on the type of link, it may be able to acquire its IPv4 address configuration using standard IPv4 address configuration mechanisms such as DHCP [RFC2131], IP Control Protocol (ICP) [RFC1332], Internet Key Exchange Protocol version 2 (IKEv2) [RFC4306], or static address configuration. However, the details on how ICP or IKEv2 can be used for address delivery are outside the scope of this document.
- o The mobile node's IPv4 home subnet is typically a shared address space. It is not for the exclusive use of any one mobile node. There can be multiple mobile nodes that are assigned IPv4 addresses from the same subnet.
- o The mobile access gateway is the IPv4 default router for the mobile node on its access link. It will be in the forwarding path for the mobile node's data traffic. Additionally, as specified in Section 6.9.3 of [RFC5213], all the mobile access gateways in the Proxy Mobile IPv6 domain MUST use the same link-layer address on any of the access links wherever the mobile node attaches.

1.2. Relevance to Dual-Stack Mobile IPv6

IPv4 support for Mobile IPv6 is specified in the Dual-Stack Mobile IPv6 specification [RFC5555]. This document leverages some of the approaches, messaging options, and processing logic defined in that document for extending IPv4 support to Proxy Mobile IPv6, except with deviation in some aspects for obvious reasons of supporting a network-based mobility model. The following are some of the related considerations.

- o The Binding Update message flag 'F' and the NAT Detection Option defined in Sections 3.1.3 and 3.2.2 of [RFC5555] are used by this specification in Proxy Binding Update and Proxy Binding Acknowledgement messages. Their sole purpose is to allow forcing

of UDP encapsulation between a mobile access gateway and a local mobility anchor in situations similar to those discussed in Sections 4.1 and 4.4.1 of [RFC5555].

- o The necessary extensions to the conceptual data structures, Binding Cache entry and Binding Update List entry, for storing the state related to the IPv4 support defined in [RFC5555], will all be needed and relevant for this document.
- o In Mobile IPv6 [RFC3775] and in Dual-Stack Mobile IPv6 [RFC5555], IPsec security associations (SAs) are specific to a single mobile node; they use the identifier visible to upper-layer protocols (HoA/IPv4-HoA) as traffic selector; and the IKE/IPsec SAs need to be updated when the mobile node moves.

In Proxy Mobile IPv6 (both [RFC5213] and this document), the IPsec SAs are specific to the mobile access gateway (and used for a potentially large number of mobile nodes); they use the locators used for routing (Proxy-CoA/IPv4-Proxy-CoA) as traffic selectors; and they are not updated when the mobile node moves.

This means the IPsec processing for Mobile IPv6 and Proxy Mobile IPv6 (whether IPv6-only or dual-stack) is very different.

- o The tunneling considerations specified in [RFC5555] for supporting IPv4 transport are relevant for this document as well.

2. Conventions and Terminology

2.1. Conventions

The key words "MUST", "MUST NOT", "REQUIRED", "SHALL", "SHALL NOT", "SHOULD", "SHOULD NOT", "RECOMMENDED", "MAY", and "OPTIONAL" in this document are to be interpreted as described in RFC 2119 [RFC2119].

2.2. Terminology

All the mobility related terms used in this document are to be interpreted as defined in the Mobile IPv6 specification [RFC3775] and Proxy Mobile IPv6 specification [RFC5213]. In addition, this document introduces the following terms.

IPv4 Proxy Care-of Address (IPv4-Proxy-CoA)

The IPv4 address that is configured on the egress-interface of the mobile access gateway. When using IPv4 transport, this address will be the registered care-of address in the mobile node's Binding Cache entry and will also be the transport-endpoint of the tunnel between the local mobility anchor and a mobile access gateway.

IPv4 Local Mobility Anchor Address (IPv4-LMAA)

The IPv4 address that is configured on the egress-interface of the local mobility anchor. When using IPv4 transport, the mobile access gateway sends the Proxy Binding Update messages to this address and will be the transport-endpoint of the tunnel between the local mobility anchor and the mobile access gateway.

Mobile Node's IPv4 Home Address (IPv4-MN-HoA)

The IPv4 home address assigned to the mobile node's attached interface. This address is topologically anchored at the mobile node's local mobility anchor. The mobile node configures this address on its attached interface. If the mobile node connects to the Proxy Mobile IPv6 domain via multiple interfaces each of the interfaces are assigned a unique IPv4 address. All the IPv6 home network prefixes and the IPv4 home address assigned to a given interface of a mobile node will be managed under one mobility session.

Selective De-registration

A procedure for partial de-registration of all the addresses that belong to one address family, i.e., de-registration of either the IPv4 home address or one or more of the assigned IPv6 home network prefixes.

Encapsulation Modes

This document uses the following terms when referring to the different encapsulation modes.

IPv4-or-IPv6-over-IPv6

IPv4 or IPv6 packet carried as a payload of an IPv6 packet

IPv4-or-IPv6-over-IPv4

IPv4 or IPv6 packet carried as a payload of an IPv4 packet

IPv4-or-IPv6-over-IPv4-UDP

IPv4 or IPv6 packet carried as a payload in an IPv4 packet with a UDP header

IPv4-or-IPv6-over-IPv4-UDP-TLV

IPv4 or IPv6 packet carried as a payload in an IPv4 packet with UDP and TLV headers

IPv4-or-IPv6-over-IPv4-GRE

IPv4 or IPv6 packet carried as a payload in an IPv4 packet with a Generic Routing Encapsulation (GRE) header (but no UDP or TLV header)

3. IPv4 Home Address Mobility Support

The IPv4 home address mobility support essentially enables a mobile node in a Proxy Mobile IPv6 domain to obtain IPv4 home address configuration for its attached interfaces and be able to retain that address configuration even after performing a handoff anywhere within that Proxy Mobile IPv6 domain. This section describes the protocol operation and the required extensions to Proxy Mobile IPv6 protocol for extending IPv4 home address mobility support.

When an IPv4-enabled or a dual-stack-enabled mobile node attaches to the Proxy Mobile IPv6 domain, the mobile access gateway on the access link where the mobile node is attached will identify the mobile node and will initiate the Proxy Mobile IPv6 signaling with the mobile node's local mobility anchor. The mobile access gateway will follow the signaling considerations specified in Section 3.2 for requesting IPv4 home address mobility support. Upon the completion of the signaling, the local mobility anchor and the mobile access gateway will establish the required routing states for allowing the mobile node to use its IPv4 home address from its current point of attachment.

The mobile node on the access link using any of the standard IPv4 address configuration mechanisms supported on that access link, such as IPCP [RFC1332], IKEv2 [RFC4306], or DHCP [RFC2131], will be able to obtain an IPv4 home address (IPv4-MN-HoA) for its attached interface. Although the address configuration mechanisms for delivering the address configuration to the mobile node is independent of the Proxy Mobile IPv6 protocol operation, there needs to be some interaction between these two protocol flows. Section 3.4 identifies these interactions for supporting DHCP-based address configuration.

The support for IPv4 home address mobility is not dependent on the IPv6 home address mobility support. It is not required that the IPv6 home address mobility support needs to be enabled for providing IPv4 home address mobility support. A mobile node will be able to obtain IPv4-only, IPv6-only, or dual IPv4/IPv6 address configuration for its attached interface. The mobile node's policy profile will determine if the mobile node is entitled to both the protocol versions or a single protocol version. Based on the policy, only those protocols will be enabled on the access link. Furthermore, if the mobile node, after obtaining the address configuration on its interface, performs a handoff, either by changing its point of attachment over the same interface or to a different interface, the network will ensure the mobile node will be able to use the same IPv4 address configuration after the handoff.

Additionally, if the mobile node connects to the Proxy Mobile IPv6 domain, through multiple interfaces and simultaneously through different access networks, each of the connected interfaces will obtain a unique IPv4 home address. In such a scenario, there will be multiple Binding Cache entries for the mobile node on the local mobility anchor. All the addresses (IPv4/IPv6) assigned to a given interface will be managed as part of one mobility session, as specified in Section 5.4 of [RFC5213].

3.1. Local Mobility Anchor Considerations

3.1.1. Extensions to Binding Cache Entry

To support this feature, the conceptual Binding Cache entry data structure maintained by the local mobility anchor needs to include the following parameters.

- o The IPv4 home address assigned to the mobile node's interface and registered by the mobile access gateway. The IPv4 home address entry also includes the corresponding subnet mask. It is to be noted that this parameter is defined in [RFC5555] and is presented here for completeness.
- o The IPv4 default router address assigned to the mobile node.

3.1.2. Signaling Considerations

3.1.2.1. Processing Proxy Binding Updates

The processing rules specified in Section 5.3 of [RFC5213] are applied for processing the received Proxy Binding Update message. However, if the received Proxy Binding Update message has an IPv4 Home Address Request option, the following considerations MUST be applied additionally.

- o If there is an IPv4 Home Address Request option (Section 3.3.1) present in the received Proxy Binding Update message, but no Home Network Prefix option [RFC5213] present in the received Proxy Binding Update message, the local mobility anchor MUST NOT reject the request as specified in Section 5.3.1 of [RFC5213]. At least one instance of either of these two options, either the IPv4 Home Address Request option or the Home Network Prefix option, MUST be present. If there is not a single instance of either of these two options present in the request, the local mobility anchor MUST reject the request and send a Proxy Binding Acknowledgement message with the Status field set to `MISSING_HOME_NETWORK_PREFIX_OPTION` (missing the mobile node's home network prefix option) [RFC5213].
- o If there is at least one instance of the Home Network Prefix option [RFC5213] present in the received Proxy Binding Update message, but it is known from the mobile node's policy profile that the mobile node is not authorized for IPv6 service, or IPv6 routing is not enabled in the home network, the local mobility anchor MUST reject the request and send a Proxy Binding Acknowledgement message with the Status field set to `NOT_AUTHORIZED_FOR_IPV6_MOBILITY_SERVICE` (mobile node not authorized for IPv6 mobility service; see Section 3.3.5).
- o If there is an IPv4 Home Address Request option present in the received Proxy Binding Update message, but it is known from the mobile node's policy profile that the mobile node is not authorized for IPv4 service, or if IPv4 routing is not enabled in the home network, the local mobility anchor MUST reject the request and send a Proxy Binding Acknowledgement message with the Status field set to `NOT_AUTHORIZED_FOR_IPV4_MOBILITY_SERVICE` (mobile node not authorized for IPv4 mobility service; see Section 3.3.5).
- o If there is more than one instance of the IPv4 Home Address Request option present in the request, then the local mobility anchor MUST reject the request and send a Proxy Binding

Acknowledgement message with the Status field set to `MULTIPLE_IPV4_HOME_ADDRESS_ASSIGNMENT_NOT_SUPPORTED` (multiple IPv4 home address assignments not supported; see Section 3.3.5).

- o For associating the received Proxy Binding Update message to an existing mobility session, the local mobility anchor MUST perform the Binding Cache entry existence test by applying the following considerations.
 - * If there is at least one instance of the Home Network Prefix option [RFC5213] with a `NON_ZERO` prefix value, or, if there is an IPv4 Home Address Request option with the IPv4 address in the option set to `ALL_ZERO`, considerations from Section 5.4.1 of [RFC5213] MUST be applied.
 - * If there is an IPv4 Home Address Request option present in the request with the IPv4 address value in the option set to a `NON_ZERO` value, considerations from Section 3.1.2.7 MUST be applied.
- o If there is no existing Binding Cache entry that can be associated with the request, the local mobility anchor MUST consider this request as an initial binding registration request, and considerations from Section 3.1.2.2 MUST be applied. Additionally, if there are one or more Home Network Prefix options [RFC5213] present in the request, considerations from Section 5.3.2 of [RFC5213] MUST also be applied.
- o If there exists a Binding Cache entry that can be associated with the request, the local mobility anchor MUST apply considerations from Section 5.3.1 of [RFC5213], (point 13), to determine if the request is a re-registration or a de-registration request. If the request is a re-registration request, considerations from Section 3.1.2.3 MUST be applied, and if it is a de-registration request, considerations from Section 3.1.2.5 MUST be applied.
- o If there exists a Binding Cache entry that can be associated with the request and if it is determined that the request is a re-registration request for extending an IPv4 home address mobility support to the existing IPv6-only mobility session, considerations from Section 3.1.2.2 MUST be applied with respect to IPv4 support.

3.1.2.2. Initial Binding Registration (New Mobility Session)

- o If there is an IPv4 Home Address Request option present in the Proxy Binding Update message with the IPv4 address value in the option set to ALL_ZERO, the local mobility anchor MUST allocate an IPv4 home address to the mobile node and associate it with the new mobility session created for that mobile node.
- o If there is an IPv4 Home Address Request option with the IPv4 address in the option set to a NON_ZERO value, the local mobility anchor, before accepting the request, MUST ensure that the address is topologically anchored on the local mobility anchor and furthermore that the mobile node is authorized to use that address. If the mobile node is not authorized for that specific address, the local mobility anchor MUST reject the request and send a Proxy Binding Acknowledgement message with the Status field set to NOT_AUTHORIZED_FOR_IPV4_HOME_ADDRESS (mobile node not authorized for the requesting IPv4 address; see Section 3.3.5). It MUST also include the IPv4 Home Address Reply option (Section 3.3.2). in the reply with the Status field value in the option set to 129 (Administratively prohibited).
- o If the local mobility anchor is unable to allocate an IPv4 address due to lack of resources, it MUST reject the request and send a Proxy Binding Acknowledgement message with Status field set to 130 (Insufficient resources). It MUST also include the IPv4 Home Address Reply option in the reply with the Status field value in the option set to 128 (Failure, reason unspecified).
- o Upon accepting the request, the local mobility anchor MUST create a Binding Cache entry for this mobility session. However, if the request also contains one or more Home Network Prefix options [RFC5213], there should still be only one Binding Cache entry that should be created for this mobility session. The created Binding Cache entry MUST be used for managing both IPv4 and IPv6 home address bindings. The fields in the Binding Cache entry MUST be updated with the accepted values for that session.
- o The local mobility anchor MUST establish a bidirectional tunnel to the mobile access gateway with the encapsulation mode set to the negotiated mode for carrying the IPv4 payload traffic. When using IPv6 transport, the encapsulation mode is IPv4-or-IPv6-over-IPv6 (IPv4 or IPv6 packet carried as a payload of an IPv6 packet). When using IPv4 transport, the encapsulation mode is as specified in Section 4.

- o The local mobility anchor MUST create an IPv4 host route (or a platform-specific equivalent function that sets up the forwarding) for tunneling the packets received for the mobile node's home address associated with this mobility session.
- o The local mobility anchor MUST send the Proxy Binding Acknowledgement message with the Status field set to 0 (Proxy Binding Update accepted). The message MUST be constructed as specified in Section 3.1.2.6.

3.1.2.3. Binding Lifetime Extension (No Handoff)

All the considerations from Section 5.3.3 of [RFC5213] MUST be applied.

3.1.2.4. Binding Lifetime Extension (after Handoff)

- o If there is no Home Network Prefix option [RFC5213] present in the request, but if the Binding Cache entry associated with this request has IPv6 home network prefix(es), the local mobility anchor MUST consider this as a request to extend lifetime only for the IPv4 home address and not for the IPv6 home network prefix(es). Hence, the local mobility anchor SHOULD release all the IPv6 home network prefix(es) assigned to that mobile node and for that specific attached interface. Similar considerations apply for the case where there is no IPv4 Home Address Request option present in the request, but if the Binding Cache entry associated with that request has both IPv4 home address and IPv6 home network prefix(es).
- o The local mobility anchor MUST remove the previously created IPv4 host route (or the forwarding state) and the dynamically created bidirectional tunnel for carrying the IPv4 payload traffic (if there are no other mobile nodes for which the tunnel is being used). This will remove the routing state towards the mobile access gateway where the mobile node was anchored prior to the handoff.
- o The local mobility anchor MUST create a bidirectional tunnel to the mobile access gateway that sent the request (if there is no existing bidirectional tunnel) and with the encapsulation mode set to the negotiated mode for carrying the IPv4 payload traffic. An IPv4 host route for tunneling the packets received for the mobile node's IPv4 home address MUST also be added.

- o The required forwarding state identified in Section 5.3.6 of [RFC5213] is for IPv6 payload traffic. Those considerations apply for IPv4 payload traffic as well. However, if IPv4 transport is in use, considerations from Section 4 MUST be applied.

3.1.2.5. Binding De-Registration

All the considerations from Section 5.3.5 of [RFC5213] MUST be applied. Additionally, to remove the IPv4 state as part of the Binding Cache entry deletion, the IPv4 host route and the dynamically created bidirectional tunnel for carrying the IPv4 payload traffic (if there are no other mobile nodes for which the tunnel is being used) MUST be removed. However, if the request is for a selective de-registration (IPv4 home address only, or all the IPv6 home network prefixes), the Binding Cache entry MUST NOT be deleted, only the respective states related to those addresses MUST be deleted.

3.1.2.6. Constructing the Proxy Binding Acknowledgement Message

When sending the Proxy Binding Acknowledgement message to the mobile access gateway, the local mobility anchor MUST construct the message as specified in Section 5.3.6 of [RFC5213]. Additionally, the following considerations MUST be applied.

- o Section 5.3.6 of [RFC5213] requires the local mobility anchor to include at least one instance of the Home Network Prefix option [RFC5213] in the Proxy Binding Acknowledgement message that it sends to the mobile access gateway. However, if the received Proxy Binding Update message has only the IPv4 Home Address Request option and does not contain the Home Network Prefix option(s), then the local mobility anchor MUST NOT include any Home Network Prefix option(s) in the reply. However, there MUST be at least one instance of either the Home Network Prefix option [RFC5213] or the IPv4 Home Address Reply option present in the Proxy Binding Acknowledgement message.
- o The IPv4 Home Address Reply option MUST be present in the Proxy Binding Acknowledgement message.
 1. If the Status field is set to a value greater than or equal to 128, i.e., if the Proxy Binding Update is rejected, then there MUST be an IPv4 Home Address Reply option corresponding to the IPv4 Home Address Request option present in the request and with the IPv4 address value and the prefix length fields in the option set to the corresponding values in the request. The Status field value in the option must be set to the specific error code.

2. For all other cases, there MUST be an IPv4 Home Address Reply option to carry the IPv4 home address assigned for that mobility session and with the value in the option set to the allocated IPv4 address. The prefix length in the option MUST be set to the prefix length of the mobile node's IPv4 home network. The Status field value in the option must be set to 0 (Success).
- o The IPv4 Default-Router Address option (Section 3.3.3) MUST be present, if the Status field value in the Proxy Binding Acknowledgement message is set to 0 (Proxy Binding Update accepted) [RFC5213]. Otherwise, the option MUST NOT be present. If the option is present, the default router address in the option MUST be set to the mobile node's default router address.

3.1.2.7. Binding Cache Entry Lookup Considerations

The Binding Cache entry lookup considerations specified in Section 5.4.1.1 of [RFC5213] uses the Home Network Prefix option [RFC5213] as the key parameter for identifying the Binding Cache entry. However, when there is not a single Home Network Prefix option with a NON_ZERO value present in the request, but there is an IPv4 Home Address option with a NON_ZERO value present in the request, then the following considerations MUST be applied.

- o The search rules specified in Section 5.4.1.1 of [RFC5213], which primarily uses IPv6 home network prefix set as the search key, are equally valid when using a single IPv4 home address as the key. When applying those considerations, instead of the IPv6 home network prefix(es), the IPv4 home address from the IPv4 Home Address option present in the request MUST be used as the search key.
- o The rules specified in Section 5.4.1.1 of [RFC5213] assume the presence of one or more IPv6 home network prefixes in the received request and also in the Binding Cache entry. But, when using the IPv4 home address as the search key, these considerations MUST always assume just one single IPv4 home address, both in the request and also in the Binding Cache entry.

3.1.3. Routing Considerations for the Local Mobility Anchor

Intercepting Packets Sent to the Mobile Node's IPv4 Home Address:

- o When the local mobility anchor is serving a mobile node, it MUST advertise a connected route into the Routing Infrastructure for the mobile node's IPv4 home address or for its home subnet, in order to receive packets that are sent to the mobile node's IPv4

home address. This essentially enables IPv4 routers in that network to detect the local mobility anchor as the last-hop router for that subnet.

Forwarding Packets to the Mobile Node:

- o On receiving a packet from a corresponding node with the destination address matching the mobile node's IPv4 home address, the local mobility anchor MUST forward the packet through the bidirectional tunnel setup for that mobile node.
- o The format of the tunneled packet when payload protection is not enabled:

```

IPv6 header (src= LMAA, dst= Proxy-CoA      /* Tunnel Header */
IPv4 header (src= CN, dst= IPv4-MN-HOA )   /* Packet Header */
Upper-layer protocols                      /* Packet Content*/

```

Figure 2: Tunneled Packets from the Local Mobility Anchor (LMA) to the Mobile Access Gateway (MAG)

Forwarding Packets Sent by the Mobile Node:

- o All the reverse tunneled packets that the local mobility anchor receives from the mobile access gateway, after removing the tunnel header, MUST be routed to the destination specified in the inner IPv4 packet header. These routed packets will have the Source Address field set to the mobile node's IPv4 home address.

3.1.4. ECN and Payload Fragmentation Considerations

The Explicit Congestion Notification (ECN) considerations specified in Section 5.6.3 of [RFC5213] apply for the IPv4 payload packets as well. The mobility agents at the tunnel entry and exit points MUST handle ECN information as specified in that document.

The mobility agents at the tunnel entry and exit points MUST apply the IP packet fragmentation considerations as specified in Section 7 of [RFC2473]; additionally, they MUST apply the considerations related to tunnel error processing and reporting as specified in Section 8 of [RFC2473].

3.2. Mobile Access Gateway Considerations

3.2.1. Extensions to Binding Update List Entry

To support the IPv4 home address mobility feature, the conceptual Binding Update List entry data structure needs to be extended with the following additional fields.

- o The IPv4 home address assigned to the mobile node's attached interface. This IPv4 home address may have been statically configured in the mobile node's policy profile, or, may have been dynamically allocated by the local mobility anchor. The IPv4 home address entry also includes the corresponding subnet mask.
- o The IPv4 default router address of the mobile node. This is acquired from the mobile node's local mobility anchor through the received Proxy Binding Acknowledgement message.

3.2.2. Extensions to Mobile Node's Policy Profile

To support the IPv4 home address mobility support feature, the mobile node's policy profile, specified in Section 6.2 of [RFC5213], MUST be extended with the following additional fields.

Extensions to the mandatory section of the policy profile:

- o This field identifies all the IP versions for which the home address mobility support needs to be extended to the mobile node. The supported modes are IPv4-only, IPv6-only, and dual IPv4/IPv6.

Extensions to the optional section of the policy profile:

- o The IPv4 home address assigned to the mobile node's attached interface. The specific details on how the network maintains the association between the address and the attached interface is outside the scope of this document. This address field also includes the corresponding subnet mask.

3.2.3. Signaling Considerations

3.2.3.1. Mobile Node Attachment and Initial Binding Registration

After detecting a new mobile node on its access link, the mobile access gateway on the access link MUST determine if IPv4 home address mobility support needs to be enabled for that mobile node. The mobile node's policy profile identifies the supported modes (IPv4-only, IPv6-only, or dual IPv4/IPv6) for that mobile node for which

the mobile service needs to be enabled. Based on those policy considerations and from other triggers such as from the network, if it is determined that IPv4 home address mobility support needs to be enabled for the mobile node, considerations from Section 6.9.1.1 of [RFC5213] MUST be applied with the following exceptions.

- o The IPv4 Home Address Request option MUST be present in the Proxy Binding Update message.
 - * If the mobile access gateway learns the mobile node's IPv4 home address either from its policy profile or from other means, the mobile access gateway MAY ask the local mobility anchor to allocate that specific address by including exactly one instance of the IPv4 Home Address Request option with the IPv4 home address and the prefix length fields in the option set to that specific IPv4 address and the prefix length of the corresponding home network.
 - * The mobile access gateway MAY also ask the local mobility anchor for dynamic IPv4 home address allocation. It can include exactly one instance of the IPv4 Home Address option with the IPv4 home address and the prefix length fields in the option set to the ALL_ZERO value. Furthermore, the (P) flag in the option MUST be set to 0. This serves as a request to the local mobility anchor for the IPv4 home address allocation.
- o The Proxy Binding Update message MUST be constructed as specified in Section 6.9.1.5 of [RFC5213]. However, the Home Network Prefix option(s) [RFC5213] MUST be present in the Proxy Binding Update only if IPv6 home address mobility support also needs to be enabled for the mobile node. Otherwise, the Home Network Prefix option(s) MUST NOT be present.
- o When using IPv4 transport to carry the signaling messages, the related considerations from Section 4 MUST be applied additionally.

3.2.3.2. Receiving Proxy Binding Acknowledgement

All the considerations from Section 6.9.1.2 of [RFC5213] MUST be applied with the following exceptions.

- o If the received Proxy Binding Acknowledgement message has the Status field value set to NOT_AUTHORIZED_FOR_IPV4_MOBILITY_SERVICE (The mobile node is not authorized for IPv4 mobility service), the mobile access gateway SHOULD NOT send a Proxy Binding Update message including a IPv4 Home Address Request option until an administrative action is taken.

- o If the received Proxy Binding Acknowledgement message has the Status field value set to NOT_AUTHORIZED_FOR_IPV4_HOME_ADDRESS (The mobile node is not authorized for the requesting IPv4 home address), the mobile access gateway SHOULD NOT request the same IPv4 address again, but MAY request the local mobility anchor to perform the address assignment by including exactly one instance of the IPv4 Home Address Request option with the IPv4 home address and the prefix length fields in the option set to the ALL_ZERO value.
- o If the received Proxy Binding Acknowledgement message has the Status field value set to NOT_AUTHORIZED_FOR_IPV6_MOBILITY_SERVICE (The mobile node is not authorized for IPv6 mobility service), the mobile access gateway SHOULD NOT send a Proxy Binding Update message including any Home Network Prefix option(s) until an administrative action is taken.
- o If there is no IPv4 Home Address Reply option present in the received Proxy Binding Acknowledgement message, the mobile access gateway MUST NOT enable IPv4 support for the mobile node and the rest of the considerations from this section can be skipped.
- o If the received Proxy Binding Acknowledgement message has the Status field value in the IPv4 Home Address Reply option set to a value that indicates that the request was rejected by the local mobility anchor, the mobile access gateway MUST NOT enable IPv4 mobility support.
- o If the received Proxy Binding Acknowledgement message has the Status field value set to 0 (Proxy Binding Update accepted), the mobile access gateway MUST update a Binding Update List entry for that mobile node. The entry MUST be updated with the assigned IPv4 home address and other accepted registration values.
- o If the received Proxy Binding Acknowledgement message has the Status field value set to 0 (Proxy Binding Update accepted) and has the IPv4 Home Address Reply option set to a value that indicates that the request was accepted by the local mobility anchor, the mobile access gateway MUST establish a bidirectional tunnel to the local mobility anchor (if there is no existing bidirectional tunnel to that local mobility anchor) and with the encapsulation mode set to IPv4-or-IPv6-over-IPv6 (an IPv4 or IPv6 packet carried as a payload of an IPv6 packet). Considerations from Section 5.6.1 of [RFC5213] MUST be applied for managing the dynamically created bidirectional tunnel. However, when using IPv4 transport, the encapsulation mode MUST be set to the negotiated encapsulation mode, as specified in Section 4 of this document.

- o The mobile access gateway MUST set up the route for forwarding the IPv4 packets received from the mobile node (using its IPv4 home address) through the bidirectional tunnel set up for that mobile node.
- o The default router address MUST be obtained from the IPv4 Default-Router Address option present in the received Proxy Binding Acknowledgement message. The mobile access gateway SHOULD configure this address on its interface and respond to any Address Resolution Protocol (ARP) requests sent by the mobile node to resolve the hardware address of the default router. However, since the link between the mobile access gateway and the mobile node is a point-to-point link, implementations will be able to receive any packets sent to the default router address without having to explicitly configure the default router address on its interface. The mobile access gateway MAY also use the default router address as the source address for any datagrams sent to the mobile node and originated by the mobile access gateway itself. It MUST also use this address in the DHCP Router option [RFC2132] in the DHCP messages.
- o If there is an IPv4 DHCP Support Mode option (Section 3.3.4) present in the received Proxy Binding Acknowledgement message and if the (S) flag in the option is set to a value of (1), then the mobile access gateway MUST function as a DHCP server for the mobile node. If either the (S) flag in the option is set to a value of (0), or if the option is not present in the request, then the mobile access gateway MUST function as a DHCP Relay for the mobile node.

3.2.3.3. Binding Re-Registration and De-Registrations

When sending a Proxy Binding Update either to extend the lifetime of a mobility session or to de-register the mobility session, the respective considerations from [RFC5213] MUST be applied. Furthermore, the following additional considerations MUST also be applied.

- o If there is an IPv4 home address assigned to the mobility session, then there MUST be exactly one instance of the IPv4 Home Address Request option present in the Proxy Binding Update message. The IPv4 home address and the prefix length fields in the option MUST be set to that specific address and its corresponding subnet-mask length.
- o If there was no IPv4 home address requested in the initial Proxy Binding Update message, but it is determined that the IPv4 home address MUST be requested subsequently, then there MUST be exactly

one instance of the IPv4 Home Address Request option present in the Proxy Binding Update message. The IPv4 home address in the option MUST be set to either ALL_ZERO or to a specific address that is being requested.

- o For performing selective de-registration of IPv4 home address but still retaining the mobility session with all the IPv6 home network prefixes, the Proxy Binding Update message with the lifetime value of (0) MUST NOT include any IPv6 Home Network Prefix options [RFC5213]. It MUST include exactly one instance of the IPv4 Home Address Request option with the IPv4 home address and the prefix length fields in the option set to the IPv4 home address that is being de-registered. Similarly, for selective de-registration of all the IPv6 home network prefixes, the Proxy Binding Update message MUST NOT include the IPv4 Home address option, it MUST include a Home Network Prefix option for each of the assigned home network prefixes assigned for that mobility session and with the prefix value in the option set to that respective prefix value.
- o The Home Network Prefix option(s) [RFC5213] MUST NOT be present if the same option(s) was not present in the initial Proxy Binding Update message. Otherwise, considerations from [RFC5213] with respect to this option MUST be applied.
- o If at any point the mobile access gateway fails to extend the binding lifetime with the local mobility anchor for the mobile node's IPv4 address, it MUST remove any forwarding state set up for the mobile node's IPv4 home address.

3.2.4. Routing Considerations for the Mobile Access Gateway

- o On receiving a packet from the bidirectional tunnel established with the mobile node's local mobility anchor, the mobile access gateway MUST remove the outer header before forwarding the packet to the mobile node.
- o On receiving a packet from a mobile node connected to its access link, the packet MUST be forwarded to the local mobility anchor through the bidirectional tunnel established with the local mobility anchor. However, when the EnableMAGLocalRouting flag is set, considerations from Section 6.10.3 of [RFC5213] MUST be applied with respect to local routing.
- o When forwarding the packet through the bidirectional tunnel, the encapsulation considerations as specified in Section 3.1.3 MUST be applied (except that the source and destination addresses fields in the outer encapsulation header are reversed). However, before

forwarding the packet, the mobile access gateway MUST ensure the source address in the received packet is the address allocated for that mobile node and that there is an active binding on the local mobility anchor for that mobile node.

- o The mobile access gateway SHOULD use the Proxy ARP [RFC0925] to reply to ARP Requests that it receives from the mobile node seeking address resolutions for the destinations on the mobile node's home subnet. When receiving an ARP Request, the mobile access gateway SHOULD examine the target IP address of the Request, and if this IP address matches the mobile node's IPv4 home subnet, it SHOULD transmit a Proxy ARP Reply. However, on certain types of links, the mobile node does not use ARP for address resolutions, instead it forwards all the packets to the mobile access gateway. On such types of links, the mobile access gateway is not required to support the Proxy ARP function. At the same time, implementations not supporting the Proxy ARP function on links where the mobile node uses ARP for seeking address resolutions for the destinations on the mobile node's home subnet will result in communication failure.

3.3. Mobility Options and Status Codes

To support the IPv4 home address mobility feature, this specification defines the following new options and status codes.

3.3.1. IPv4 Home Address Request Option

A new option, the IPv4 Home Address Request option, is defined for use with the Proxy Binding Update message sent by the mobile access gateway to the local mobility anchor. This option is used to request IPv4 home address assignment for the mobile node.

The IPv4 Home Address Request option has an alignment requirement of 4n. Its format is as follows:

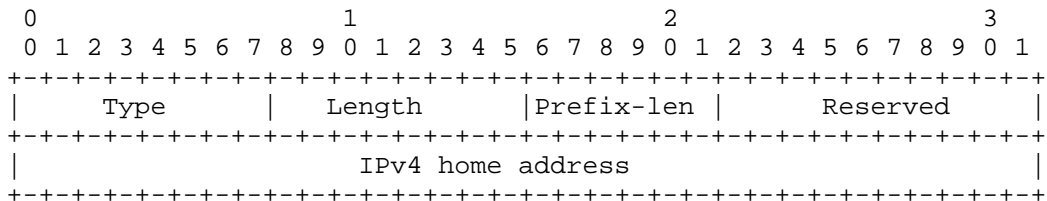

Figure 3: IPv4 Home Address Request Option

Type

36

Length

An 8-bit unsigned integer indicating the length of the option in octets, excluding the Type and Length fields. This field MUST be set to (6).

Prefix-len

This 6-bit unsigned integer indicating the prefix length of the mobile node's IPv4 home network corresponding to the IPv4 home address contained in the option.

Reserved

This 10-bit field is unused for now. The value MUST be initialized to (0) by the sender and MUST be ignored by the receiver.

IPv4 home address

This 4-byte field containing the IPv4 home address that is being requested. The value of 0.0.0.0 is used to request that the local mobility anchor perform the address allocation.

3.3.2. IPv4 Home Address Reply Option

A new option, the IPv4 Home Address Reply option, is defined for use in the Proxy Binding Acknowledgement message sent by the local mobility anchor to the mobile access gateway. This option can be used to send the assigned mobile node's IPv4 home address.

The IPv4 Home Address Reply option has an alignment requirement of 4n. Its format is as follows:

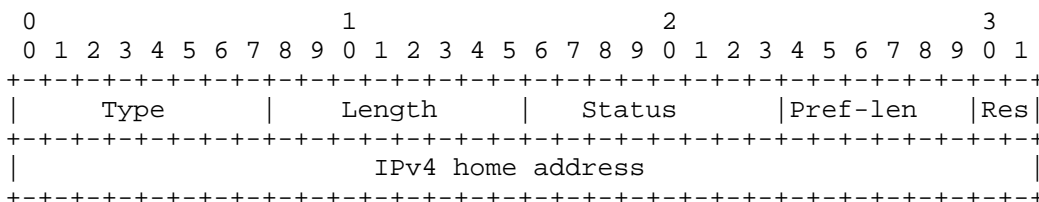

Figure 4: IPv4 Home Address Reply Option

Type

37

Length

An 8-bit unsigned integer indicating the length of the option in octets, excluding the Type and Length fields. This field MUST be set to (6).

Status

Indicates success or failure for the IPv4 home address assignment. Values from 0 to 127 indicate success. Higher values (128 to 255) indicate failure. The following Status values are currently allocated by this document:

0 Success

128 Failure, reason unspecified

129 Administratively prohibited

130 Incorrect IPv4 home address

131 Invalid IPv4 address

132 Dynamic IPv4 home address assignment not available

Prefix-len

This 6-bit unsigned integer is used to carry the prefix length of the mobile node's IPv4 home network corresponding to the IPv4 home address contained in the option.

Reserved (Res)

This 2-bit field is unused for now. The value MUST be initialized to (0) by the sender and MUST be ignored by the receiver.

IPv4 home address

This 4-byte field is used to carry the IPv4 home address assigned to the mobile node.

3.3.3. IPv4 Default-Router Address Option

A new option, the IPv4 Default-Router Address option, is defined for use in the Proxy Binding Acknowledgement message sent by the local mobility anchor to the mobile access gateway. This option can be used to send the mobile node's IPv4 default router address.

The IPv4 Default-Router Address option has an alignment requirement of 4n. Its format is as follows:

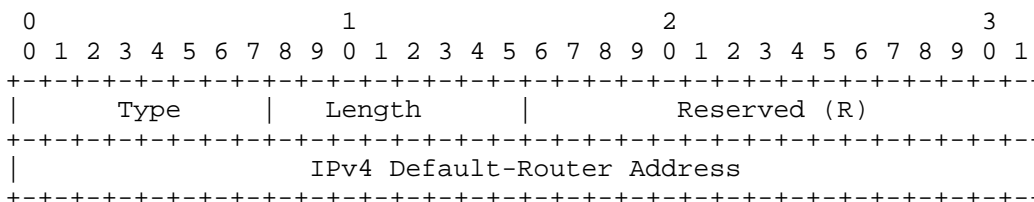

Figure 5: IPv4 Default-Router Address Option

Type

38

Length

An 8-bit unsigned integer indicating the length of the option in octets, excluding the Type and Length fields. This field MUST be set to (6).

Reserved (R)

This 16-bit field is unused for now. The value MUST be initialized to (0) by the sender and MUST be ignored by the receiver.

IPv4 Default-Router Address

A 4-byte field containing the mobile node's default router address.

3.3.4. IPv4 DHCP Support Mode Option

A new option, the IPv4 DHCP Support Mode option, is defined for use in the Proxy Binding Acknowledgement message sent by the local mobility anchor to the mobile access gateway. This option can be

used to notify the mobile access gateway as to whether it should function as a DHCP Server or a DHCP Relay for the attached mobile node.

The IPv4 DHCP Support Mode option has no alignment requirement. Its format is as follows:

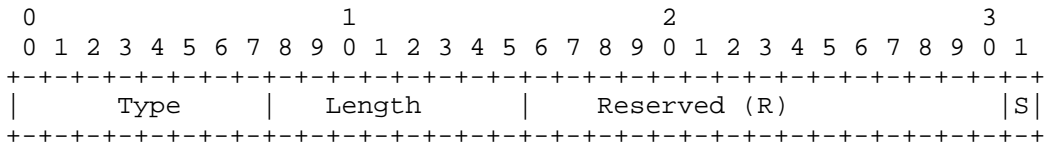

Figure 6: IPv4 DHCP Support Mode Option

Type

39

Length

An 8-bit unsigned integer indicating the length of the option in octets, excluding the Type and Length fields. This field MUST be set to 2.

Reserved (R)

This 15-bit field is unused for now. The value MUST be initialized to (0) by the sender and MUST be ignored by the receiver.

DHCP Support Mode (S)

A 1-bit field that specifies the DHCP support mode. This flag indicates whether the mobile access gateway should function as a DHCP Server or a DHCP Relay for the attached mobile node. The flag value of (0) indicates the mobile access gateway should act as a DHCP Relay, and the flag value of (1) indicates it should act as a DHCP Server.

3.3.5. Status Codes

This document defines the following new Status values for use in the Proxy Binding Acknowledgement message. These values are to be allocated from the same numbering space, as defined in Section 6.1.8 of [RFC3775].

NOT_AUTHORIZED_FOR_IPV4_MOBILITY_SERVICE: 170

Mobile node not authorized for IPv4 mobility service.

NOT_AUTHORIZED_FOR_IPV4_HOME_ADDRESS: 171

Mobile node not authorized for the requesting IPv4 home address.

NOT_AUTHORIZED_FOR_IPV6_MOBILITY_SERVICE: 172

Mobile node not authorized for IPv6 mobility service.

MULTIPLE_IPV4_HOME_ADDRESS_ASSIGNMENT_NOT_SUPPORTED: 173

Multiple IPv4 home address assignments not supported.

3.4. Supporting DHCP-Based Address Configuration

This section explains how DHCP-based address configuration support can be enabled for a mobile node in a Proxy Mobile IPv6 domain. It explains the protocol operation, supported DHCP server deployment configurations, and the protocol interactions between DHCP agents and mobility entities in each of the supported configurations.

This specification supports the following two DHCP deployment configurations.

- o DHCP relay agent co-located with the mobile access gateway.
- o DHCP server co-located in the mobile access gateway.

The following are the configuration requirements:

- o The DHCP server or the DHCP relay agent configured on the mobile access gateway is required to have an IPv4 address for exchanging the DHCP messages with the mobile node. This address is the mobile node's default router address provided by the local mobility anchor. Optionally, all the DHCP servers co-located with the mobile access gateways in the Proxy Mobile IPv6 domain can be configured with a fixed IPv4 address. This fixed address can be an IPv4 private address [RFC1918] that can be used for the DHCP protocol communication on any of the access links. This address will be used as the server identifier in the DHCP messages.
- o A DHCP server identifies a DHCP interface from the contents of the DHCP "Client-identifier" option [RFC2132], if present, or from the client hardware address (chaddr), as specified in [RFC2131]. Note that the name "Client-identifier" is a misnomer as it actually

identifies an interface and not the client. The DHCP server uses this identity to identify the interface for which the address is assigned. A mobile node in a Proxy Mobile IPv6 domain, can attach to the network through multiple interfaces and can obtain address configuration for each of its interfaces. Additionally, it may perform handoffs between its interfaces. The following are the related considerations with respect to the identification presented to the DHCP server.

- * If the mobile node attaches to the Proxy Mobile IPv6 domain through multiple physical interfaces, the DHCP server will uniquely identify each of those interfaces and will perform address assignment. The DHCP server will identify the interface as specified in RFC 2131. The mobile node SHOULD generate and use the "Client-identifier" for each physical interface according to [RFC4361]. Any time the mobile node performs a handoff of a physical interface to a different mobile access gateway, using the same interface, the DHCP server will always be able to identify the binding using the presented identifier. The presented identifier (either the "Client-identifier" or the hardware address) will remain as the primary key for each binding, just as how they are unique in a Binding Cache entry.
- * If the mobile node is capable of performing a handoff between interfaces, as per [RFC5213], a "Client-identifier" value MUST be used for the attachment point that is not tied to any of the physical interfaces. The identifier MUST be generated according to [RFC4361], which guarantees that the identifier is stable and unique across all "Client-identifier" values in use in the Proxy Mobile IPv6 domain.
- o All the DHCP servers co-located with the mobile access gateways in a Proxy Mobile IPv6 domain can be configured with the same set of DHCP option values (e.g., DNS Server, SIP Server, etc.) to ensure the mobile node receives the same configuration values on any of the access links in that Proxy Mobile IPv6 domain.

3.4.1. DHCP Server Co-Located with the Mobile Access Gateway

This section explains the operational sequence of home address assignment operation when the DHCP server is co-located with the mobile access gateway.

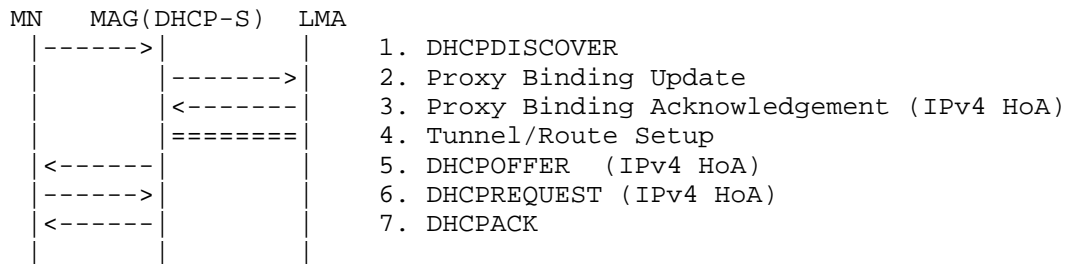

Figure 7: Overview of DHCP Server Located at Mobile Access Gateway

- o It is possible that the mobile access gateway may have already completed the Proxy Mobile IPv6 signaling with the local mobility anchor to request both IPv6 home network prefix(es) and IPv4 home address assignment prior to Step 1. In such an event, the Proxy Mobile IPv6 signaling steps (Steps 2 to 4) above are not relevant.
- o It is possible the mobile access gateway may have initially completed the Proxy Mobile IPv6 signaling prior to Step 1, but only for requesting IPv6 home network prefix(es), and it may later request IPv4 home address assignment after detecting the DHCP triggers from the mobile node as shown above.
- o The mobile access gateway may choose to ignore the DHCPDISCOVER messages until the Proxy Mobile IPv6 signaling is successfully completed, or it may choose to send a delayed response for reducing the additional delay waiting for a new DHCPDISCOVER message from the mobile node.

Initial IPv4 Home Address Assignment:

- o To acquire the mobile node's IPv4 home address from the local mobility anchor, the mobile access gateway will initiate Proxy Mobile IPv6 signaling with the local mobility anchor.
- o After the successful completion of the Proxy Mobile IPv6 signaling and upon acquiring the mobile node's IPv4 home address from the local mobility anchor, the DHCP server on the mobile access gateway will send a DHCPOFFER message [RFC2131] to the mobile node. The offered address will be the mobile node's IPv4 home address, assigned by the local mobility anchor. The DHCPOFFER message will also have the Subnet Mask option [RFC2132] and Router option [RFC2132], with the values in those options set to the mobile node's IPv4 home subnet mask and default router address, respectively. Additionally, the Server Identifier option will be included and with the value in the option set to the default router address.

- o If the mobile node sends the DHCPREQUEST message, the DHCP server will send DHCPACK message, as per [RFC2131].

IPv4 Home Address Renewal with the DHCP Server (No Handoff):

- o Any time the mobile node goes into the DHCP RENEWING state [RFC2131], it simply unicasts the DHCPREQUEST message including the assigned IPv4 home address in the 'Requested IP Address' option. The DHCPREQUEST is sent to the address specified in the Server Identifier option of the previously received DHCP OFFER and DHCPACK messages.
- o The DHCP server will send a DHCPACK to the mobile node to acknowledge the assignment of the committed IPv4 address.

IPv4 Home Address Renewal with the DHCP Server (after Handoff):

When the mobile node goes into the DHCP RENEWING state [RFC2131], it directly unicasts the DHCPREQUEST message to the DHCP server that currently provided the DHCP lease. However, if the mobile node changed its point of attachment and is attached to a new mobile access gateway, it is required that the mobile node update the DHCP server address and use the address of the DHCP server that is co-located with the new mobile access gateway. The following approach can be adopted to ensure the mobile node uses the DHCP server on the attached link.

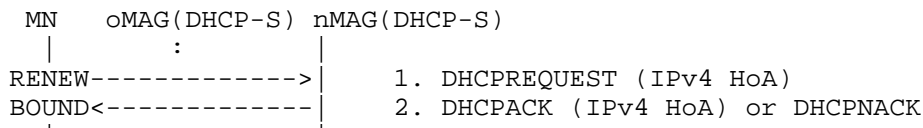

* The use of a fixed DHCP server address on all DHCP servers

Figure 8: Address Renewal with the DHCP Server

- o The use of a stable address, either the IPv4 default router address of the mobile node or a fixed IPv4 address common in that Proxy Mobile IPv6 domain, as the DHCP Server Identifier will ensure the DHCPREQUEST message sent by the mobile node to renew the address will be received by the new mobile access gateway on the attached link.
- o The mobile access gateway after completing the Proxy Mobile IPv6 signaling and upon acquiring the IPv4 home address of the mobile node will return the address in the DHCPACK message. However, if the mobile access gateway is unable to complete the Proxy Mobile

IPv6 signaling or is unable to acquire the same IPv4 address as requested by the mobile node, it will send a DHCPNACK message [RFC2131] to the mobile node, as shown in Figure 8.

3.4.2. DHCP Relay Agent Co-Located with the Mobile Access Gateway

A DHCP relay agent is co-located with each mobile access gateway. A DHCP server is located somewhere in the Proxy Mobile IPv6 domain (e.g., is co-located with the local mobility anchor). Figure 9 shows the sequence of IPv4 home address assignment using DHCP Relay.

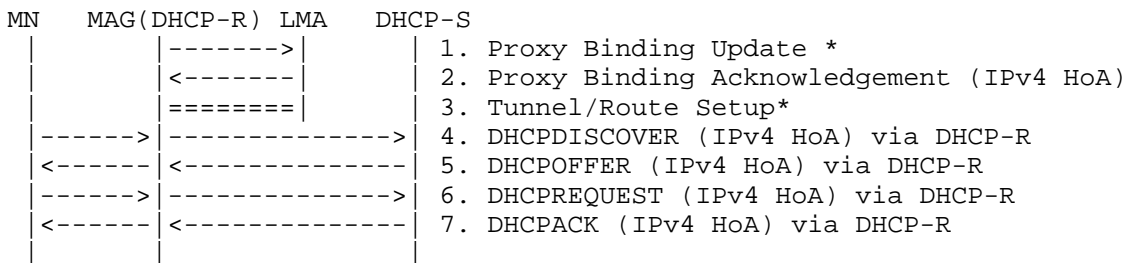

Figure 9: Overview of the DHCP Relay Located at Mobile Access Gateway

- o The Proxy Mobile IPv6 signaling (starting at Step 1) and the DHCP address configuration (starting at Step 4) may start in any order. However, the DHCPOFFER (Step 5) and the immediate steps following it will occur in the specified order and only after the Tunnel/Route Setup (Step 3).
- o It is possible the mobile access gateway may have initially completed the Proxy Mobile IPv6 signaling with the local mobility anchor only to request IPv6 home network prefix(es) and may later request IPv4 home address assignment after detecting the DHCP triggers from the mobile node (after Step 4).
- o The mobile access gateway may choose to ignore the DHCPDISCOVER messages until the Proxy Mobile IPv6 signaling is successfully completed, or it may choose to send a delayed response for reducing the additional delay waiting for a new DHCPDISCOVER message from the mobile node.

Initial IPv4 Home Address Assignment:

- o To acquire the mobile node's IPv4 home address from the local mobility anchor, the mobile access gateway will initiate Proxy Mobile IPv6 signaling with the local mobility anchor.

- o After the successful completion of the Proxy Mobile IPv6 signaling and upon acquiring the mobile node's IPv4 home address from the local mobility anchor, the mobile access gateway will enable forwarding for all the DHCP messages between the mobile node and the DHCP server.
- o The DHCP relay agent on the mobile access gateway will add the DHCP Relay Agent Information option [RFC3046] to the DHCPDISCOVER message. The assigned IPv4 home address will be included in the Agent Remote ID Sub-option of the DHCP Relay Agent Information option. This sub-option is used as a hint for requesting the DHCP server to allocate that specific IPv4 address.
- o On receiving a DHCPOFFER message from the DHCP server, the mobile access gateway will ensure the assigned address is currently assigned by the local mobility anchor to that mobile node. If this address is different from what is assigned to the mobile node, then the mobile access gateway will drop the DHCPOFFER message and an administrative error message will be logged.
- o When the DHCP messages are sent over administrative boundaries, the operators need to ensure these messages are secured. All the DHCP messages relayed by the mobile access gateway can be tunneled to the local mobility anchor if needed. Alternatively, if the network in the Proxy Mobile IPv6 domain is secure enough, the mobile access gateway can just relay the DHCP messages to the server. To achieve this, all the mobile access gateways need to have a route towards the DHCP server.

IPv4 Home Address Renewal to the same DHCP Server: (No Handoff)

- o When the DHCP client goes into the DHCP RENEW STATE [RFC2131], it directly unicasts DHCPREQUEST messages to the DHCP server. The DHCP relay agent may not detect any changes in the DHCP state. For example, if the mobile node releases the IPv4 address, the relay agent would not be aware of it. The following describes additional mechanisms for the mobile access gateway to detect any changes in the DHCP state.
 - * The DHCP relay agent can intercept all IPv4 DHCP packets destined to the set of addresses used within the Proxy Mobile IPv6 domain as DHCP addresses. Since the link between a mobile node and a mobile access gateway is the point-to-point link, the mobile access gateway will be in path for all the messages.
 - * The DHCP relay agent can use the DHCP Server Identifier Override Sub-option [RFC5107] to be in path for all the DHCP message flows. The DHCP client uses the DHCP server address

that is overridden by the DHCP relay agent address as a destination address of DHCPREQUEST. The DHCP Server Identifier Override Sub-option is recommended only when the fixed DHCP relay address is configured on all the mobile access gateways. Otherwise, the DHCP relay agent address is changed when the mobile node changes the attached mobile access gateway.

- o However, if the DHCP server is co-located with the local mobility anchor, then the DHCP relay agent is not required to intercept the unicast DHCP messages between the mobile node and the DHCP server. This is because the local mobility anchor will ensure that the DHCP state is consistent with the Proxy Mobile IPv6 binding that exists for the IPv4 address.
- o Once the mobile access gateway intercepts the DHCP message from the mobile node to the DHCP server, it can verify if the mobile node is negotiating the same IPv4 address that the local mobility anchor allocated for that mobile node. If the address in the DHCPREQUEST message does not match with the IPv4 address allocated for the mobile node, then the mobile access gateway SHOULD drop the DHCP message and an administrative error message can be logged.
- o Any time the mobile access gateway detects that the mobile node has released its IPv4 address, it can send a Proxy Binding Update to the local mobility anchor and de-register the IPv4 mobility session.

3.4.3. Common DHCP Considerations

The following DHCP-related considerations are common to both the supported configuration modes, specified in Sections 3.4.1 and 3.4.2.

- o When a mobile node sends a DHCPDISCOVER message [RFC2131], the DHCP server or the relay agent co-located with the mobile access gateway will trigger the mobile access gateway to complete the Proxy Mobile IPv6 signaling. This is the required interaction between these two protocols. The mobile access gateway, on receiving this trigger, will check if there is already an assigned IPv4 home address for the mobile node, from the local mobility anchor. If there is no assigned IPv4 home address assigned for that mobile node, the mobile access gateway will complete the Proxy Mobile IPv6 signaling with the local mobility anchor by sending a Proxy Binding Update message.
- o The mobile node needs to be identified by the MN-Identifier, as specified in Section 6.6 of [RFC5213]. This identity should be associated to the DHCP messages sent by the mobile node.

- o The mobile access gateway will drop all the DHCPDISCOVER messages until it completes the Proxy Mobile IPv6 signaling. If the mobile access gateway is unable to complete the Proxy Mobile IPv6 signaling, or, if the local mobility anchor does not assign an IPv4 address for the mobile node, the mobile access gateway MUST NOT enable IPv4 home address mobility support for the mobile node on that access link.
- o The trigger for initiating Proxy Mobile IPv6 signaling can also be delivered to the mobile access gateway as part of a context transfer from the previous mobile access gateway, or delivered from the other network elements in the radio network, the details of which are outside the scope of this document.
- o The DHCPOFFER message [RFC2131] sent to the mobile node MUST include the Subnet Mask option [RFC2132] and the Router option [RFC2132]. The values in the Subnet Mask option and Router option MUST be set to the mobile node's IPv4 home subnet mask and its default router address, respectively.
- o The DHCPOFFER message [RFC2131] sent to the mobile node MUST include the Interface MTU option [RFC2132]. The DHCP servers in the Proxy Mobile IPv6 domain MUST be configured to include the Interface MTU option. The MTU value SHOULD reflect the tunnel MTU for the bidirectional tunnel between the mobile access gateway and the local mobility anchor.
- o The DHCP lease length allocated to the mobile node's IPv4 home address may be different from the binding lifetime at the local mobility anchor for that mobile node's session. It is not possible to keep these lifetimes synchronized, and so its not required that the configured lifetimes should be kept same in both DHCP and Proxy Mobile IPv6.
- o When the mobile node performs a handoff from one mobile access gateway to another, the mobile access gateway on the new link will initiate the Proxy Mobile IPv6 signaling with the local mobility anchor. On completing the Proxy Mobile IPv6 signaling, the mobile access gateway has the proper IPv4 address state that the local mobility anchor has allocated for the mobile node and that can be used for supporting DHCP based address configuration on that link.
- o Any time the mobile node detects a link change event due to handoff, or due to other reasons such as re-establishment of the link-layer, the following are the mobile node's considerations with respect to the DHCP protocol.

- * If the mobile node is DNaV4-capable (Detecting Network Attachment version 4) [RFC4436] and if it performs DNaV4 procedures after receiving a link change event, it would always detect the same default router on any of the access links in that Proxy Mobile IPv6 domain, as the mobile access gateway configures a fixed link-layer address on all the access links, as per the base Proxy Mobile IPv6 specification [RFC5213]. The mobile node will not perform any DHCP operation specifically due to this event.
- * If the mobile node is not DNaV4-capable [RFC4436], after receiving the link change event it will enter INIT-REBOOT state [RFC2131] and will send a DHCPREQUEST message as specified in Section 3.7 of [RFC2131]. The mobile node will obtain the same address configuration as before, as the link change does not result in any change at the network layer.
- o The mobile node may release its IPv4 home address at any time by sending the DHCPRELEASE message [RFC2131]. When the mobile access gateway detects the DHCPRELEASE message sent by the mobile node, it should consider this as a trigger for de-registering the mobile node's IPv4 home address. It will apply the considerations specified in Section 3.2.3.3 for performing the de-registration procedure. However, this operation MUST NOT release any IPv6 home network prefix(es) assigned to the mobile node.

4. IPv4 Transport Support

The Proxy Mobile IPv6 specification [RFC5213] requires the signaling messages exchanged between the local mobility anchor and the mobile access gateway to be over an IPv6 transport. However, in some cases, the local mobility anchor and the mobile access gateway are separated by an IPv4 network.

The normal Proxy Mobile IPv6 specification [RFC5213] can be run over an IPv4 transport without any modifications by using a transition technology that allows IPv6 hosts to communicate over IPv4 networks. For example, the mobile access gateway and the local mobility anchor could have a simple configured IPv6-over-IPv4 tunnel. Instead of configured tunnels, various mechanisms for automatic tunneling could be used, too. To these tunnels, Proxy Mobile IPv6 would look just like any other application traffic running over IPv6.

However, treating Proxy Mobile IPv6 just like any other IPv6 traffic would mean an extra layer of encapsulation for the mobile node's tunneled data traffic, adding 40 octets of overhead for each packet.

The extensions defined in this section allow the mobile access gateway and the local mobility anchor to communicate over an IPv4 network without this overhead.

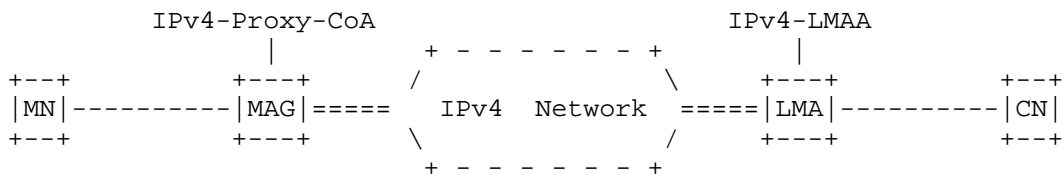

Figure 10: IPv4 Transport Network

When the local mobility anchor and the mobile access gateway are configured and reachable using only IPv4 addresses, the mobile access gateway serving a mobile node can potentially send the signaling messages over IPv4 transport and register its IPv4 address as the care-of address in the mobile node's Binding Cache entry. An IPv4 tunnel (with any of the supported encapsulation modes) can be used for tunneling the mobile node's data traffic. The following are the key aspects of this feature.

- o The local mobility anchor and the mobile access gateway are both configured and reachable using an IPv4 address of the same scope.
- o The IPv4 addresses used can be private IPv4 addresses, but it is assumed that there is no NAT between the local mobility anchor and the mobile access gateway. However, it is possible to use UDP encapsulation if other types of middleboxes are present.
- o The Mobility Header [RFC3775] is carried inside an IPv4 packet with UDP header (IPv4-UDP-MH), using a UDP port number for Proxy Mobile IPv6 signaling over IPv4.
- o The mobile node can be an IPv6, IPv4, or a dual IPv4/IPv6 node and the IPv4 transport support specified in this section is agnostic to the type of address mobility enabled for that mobile node.
- o The mobile node's data traffic will be tunneled between the local mobility anchor and the mobile access gateway. There are several encapsulation modes available:
 - * IPv4 (IPv4 or IPv6 payload packet carried in an IPv4 packet). If payload protection using IPsec is enabled for the tunneled traffic, the Encapsulating Security Payload (ESP) header follows the outer tunnel header.

- * IPv4-UDP (payload packet carried in an IPv4 packet with UDP header, using a UDP port number for Proxy Mobile IPv6 data; this is different port than is used for signaling). If payload protection using IPsec is enabled, the ESP header follows the outer IPv4 header, as explained in Section 4.3.
- * IPv4-UDP-TLV (payload packet carried in an IPv4 packet with UDP and TLV header) and IPv4-GRE (Payload packet carried in an IPv4 packet with GRE header). Refer to [GREKEY]. If payload protection using IPsec is enabled, the ESP header follows the outer IPv4 header, as explained in Section 4.3.

4.1. Local Mobility Anchor Considerations

4.1.1. Extensions to Binding Cache Entry

To support this feature, the conceptual Binding Cache entry data structure maintained by the local mobility anchor [RFC5213] MUST be extended with the following additional parameters. It is to be noted that all of these parameters are specified in [RFC5555] and also required here in the present usage context, and are presented here only for completeness.

- o The IPv4 Proxy Care-of Address configured on the mobile access gateway that sent the Proxy Binding Update message. The address MUST be the same as the source address of the received IPv4 packet that contains the Proxy Binding Update message. However, if the received Proxy Binding Update message is not sent as an IPv4 packet, i.e., when using IPv6 transport, this field in the Binding Cache entry MUST be set to the ALL_ZERO value.

4.1.2. Extensions to Mobile Node's Policy Profile

To support the IPv4 Transport Support feature, the mobile node's policy profile, specified in Section 6.2 of [RFC5213], MUST be extended with the following additional fields. These are mandatory fields of the policy profile required for supporting this feature.

- o The IPv4 address of the local mobility anchor (IPv4-LMAA).

4.1.3. Signaling Considerations

This section provides the rules for processing the Proxy Mobile IPv6 signaling messages received over IPv4 transport.

4.1.3.1. Processing Proxy Binding Updates

- o If the Proxy Binding Update message is protected with IPsec ESP, IPsec processing happens before the packet is passed to Proxy Mobile IPv6.
- o All the considerations from Section 5.3.1 of [RFC5213] except Step 1 (about IPsec) MUST be applied on the encapsulated Proxy Binding Update message. Note that the Checksum field in Mobility Header MUST be ignored.
- o Upon accepting the request, the local mobility anchor MUST set up an IPv4 bidirectional tunnel to the mobile access gateway. The tunnel endpoint addresses are IPv4-LMAA and the IPv4-Proxy-CoA. The encapsulation mode MUST be determined by applying the following considerations:
 - * If the (F) flag in the received Proxy Binding Update message is set to the value of (1), but if the configuration flag, AcceptForcedIPv4UDPEncapsulationRequest, is set to a value of (0), then the local mobility anchor MUST reject the request with the Status field value set to 129 (Administratively prohibited).
 - * If the (T) flag is set to (1), or GRE Key option is included, see [GREKEY].
 - * If the (F) flag in the received Proxy Binding Update message is set to the value of (1), then the encapsulation mode MUST be set to IPv4-UDP. Otherwise, the encapsulation mode MUST be set to IPv4.
- o The local mobility anchor MUST send the Proxy Binding Acknowledgement message with the Status field value set to (0) (Proxy Binding Update accepted). The message MUST be constructed as specified in Section 4.1.3.2.

4.1.3.2. Constructing the Proxy Binding Acknowledgement Message

The local mobility anchor when sending the Proxy Binding Acknowledgement message to the mobile access gateway MUST construct the message as specified in Section 5.3.6 of [RFC5213]. However, if the Proxy Binding Update message was received over IPv4, the following additional considerations MUST be applied.

- o The IPv6 Header is removed, and the Mobility Header containing the Proxy Binding Acknowledgement is encapsulated in UDP (with source port set to 5436 and destination port set to the source port of

the received Proxy Binding Update message). The Mobility Header Checksum field MUST be set to zero (and the UDP checksum MUST be used instead).

- o The source address in the IPv4 header of the message MUST be set to the destination IPv4 address of the received request.
- o If IPsec ESP is used to protect signaling, the packet is processed using transport mode ESP as described in Section 4.3.
- o Figure 11 shows the format of the Proxy Binding Acknowledgement message sent over IPv4 and protected using ESP.

```
IPv4 header (src=IPv4-LMAA, dst=pbu_src_address)
  ESP header (in transport mode)
    UDP header (sport=5436, dport=5436)
      Mobility Header (PBA)
```

Figure 11: Proxy Binding Acknowledgement (PBA) Message Sent over IPv4

4.1.4. Routing Considerations

4.1.4.1. Forwarding Considerations

Forwarding Packets to the Mobile Node:

- o On receiving an IPv4 or an IPv6 packet from a correspondent node with the destination address matching any of the mobile node's IPv4 or IPv6 home addresses, the local mobility anchor MUST forward the packet through the bidirectional tunnel set up for that mobile node.
- o The format of the tunneled packet is shown below. The IPv4-UDP-TLV and IPv4-GRE encapsulation modes are described in [GREKEY].

```
IPv4 Header (src=IPv4-LMAA, dst=IPv4-Proxy-CoA)] /* Tunnel Header */
[UDP Header (src port=5437, dst port=5437] /* If UDP encap nego */
/* IPv6 or IPv4 Payload Packet */
IPv6 header (src=CN, dst=MN-HOA)
OR
IPv4 header (src=CN, dst=IPv4-MN-HoA)
```

Figure 12: Tunneled IPv4 Packet from LMA to MAG (IPv4 or IPv4-UDP Encapsulation Mode)

- o Forwarding Packets Sent by the Mobile Node:

- * All the reverse tunneled packets (IPv4 and IPv6) that the local mobility anchor receives from the mobile access gateway, after removing the tunnel header (i.e., the outer IPv4 header along with the UDP and TLV header, if negotiated) MUST be routed to the destination specified in the inner packet header. These routed packets will have the source address field set to the mobile node's home address.

4.1.4.2. ECN and Payload Fragmentation Considerations

The ECN considerations specified in Section 5.6.3 of [RFC5213] apply for the IPv4 transport tunnels as well. The mobility agents at the tunnel entry and exit points MUST handle ECN information as specified in that document.

The mobility agents at the tunnel entry and exit points MUST apply the IP packet fragmentation considerations as specified in [RFC4213]. Additionally, they MUST also apply the considerations related to tunnel error processing and reporting as specified in the same specification.

4.1.4.3. Bidirectional Tunnel Management

The Tunnel Management considerations specified in Section 5.6.1 of [RFC5213] apply for the IPv4 transport tunnels as well, with just one difference that the encapsulation mode is different.

4.2. Mobile Access Gateway Considerations

4.2.1. Extensions to Binding Update List Entry

To support the IPv4 Transport Support feature, the conceptual Binding Update List entry data structure maintained by the mobile access gateway [RFC5213] MUST be extended with the following additional parameters.

- o The IPv4 address of the local mobility anchor. This address can be obtained from the mobile node's policy profile.

4.2.2. Signaling Considerations

The mobile access gateway, when sending a Proxy Binding Update message to the local mobility anchor, MUST construct the message as specified in Section 6.9.1.5 of [RFC5213]. However, if the mobile access gateway is in an IPv4-only access network, the following additional considerations MUST be applied.

- o The Proxy Binding Update message MUST be sent over IPv4 as described in Section 4.2.2.1.
- o Just as specified in [RFC5213], when sending a Proxy Binding Update message for extending the lifetime of a currently existing mobility session or to de-register the mobility session, the Proxy Binding Update message MUST be constructed just as the initial request.

Receiving Proxy Binding Acknowledgement:

- o If the received Proxy Binding Acknowledgement message is protected with IPsec ESP, IPsec processing happens before the packet is passed to Proxy Mobile IPv6. Considerations from Section 4 of [RFC5213] MUST be applied to authenticate and authorize the message.
- o All the considerations from Section 6.9.1.2 of [RFC5213] MUST be applied on the encapsulated Proxy Binding Acknowledgement message. Note that the Checksum field in Mobility Header MUST be ignored.
- o If the Status field indicates Success, the mobile access gateway MUST set up a bidirectional tunnel to the local mobility anchor.
- o Upon accepting the request, the mobile access gateway MUST set up an IPv4 bidirectional tunnel to the local mobility anchor. The tunnel endpoint addresses are the IPv4-Proxy-CoA and the IPv4-LMAA. The encapsulation mode MUST be determined from the below considerations:
 - * If the (T) flag is set to (1), or the GRE Key option is included, see [GREKEY].
 - * If there is a NAT Detection option [RFC5555] in the received Proxy Binding Acknowledgement message, and the (F) flag is set to value of (1), the encapsulation mode for the tunnel MUST be set to IPv4-UDP. Otherwise, the encapsulation mode MUST be set to IPv4.

4.2.2.1. Constructing the Proxy Binding Update Message

- o The IPv6 Header is removed, and the Mobility Header containing the Proxy Binding Update message is encapsulated in UDP (with the destination port set to 5436). The Mobility Header Checksum field MUST be set to zero (and UDP checksum MUST be used instead).

- o The source address in the IPv4 header MUST be set to IPv4-Proxy-CoA of the mobile access gateway and the destination address MUST be set to the local mobility anchor's IPv4-LMAA.
- o If the configuration variable ForceIPv4UDPEncapsulationSupport is set to value of (1), then the (F) flag in the Proxy Binding Update message MUST be set to value of (1).
- o If IPsec ESP is used to protect signaling, the packet is processed using transport mode ESP as described in Section 4.3.
- o Figure 13 shows the format of the Proxy Binding Update message sent over IPv4 and protected using ESP.

```

IPv4 header (src=IPv4-Proxy-CoA, dst=IPv4-LMAA)
  ESP header (in transport mode)
    UDP header (sport=5436, dport=5436)
      Mobility Header (PBU)

```

Figure 13: Proxy Binding Update (PBU) Message Sent over IPv4

4.2.2.2. Forwarding Considerations

Forwarding Packets Sent by the Mobile Node:

- o On receiving an IPv4 or an IPv6 packet from the mobile node to any destination, the mobile access gateway MUST tunnel the packet to the local mobility anchor. The format of the tunneled packet is shown below. The IPv4-UDP-TLV and IPv4-GRE encapsulation modes are described in [GREKEY]. However, considerations from Section 6.10.3 of [RFC5213] MUST be applied with respect the local routing and on the use of EnableMAGLocalRouting flag.

```

IPv4 Header (src=IPv4-Proxy-CoA, dst=IPv4-LMAA)] /* Tunnel Header */
[UDP Header (src port=5437, dst port=5437] /* If UDP encap nego */
/* IPv6 or IPv4 Payload Packet */
IPv6 header (src=MN-HOA, dst=CN)
OR
IPv4 header (src=IPv4-MN-HOA, dst=CN)

```

Figure 14: Tunneled IPv4 Packet from MAG to LMA (IPv4 or IPv4-UDP Encapsulation Mode)

Forwarding Packets Received from the Bidirectional Tunnel:

- o On receiving a packet from the bidirectional tunnel established with the mobile node's local mobility anchor, the mobile access gateway MUST remove the outer header before forwarding the packet to the mobile node.

4.3. IPsec Considerations

4.3.1. PBU and PBA

The following section describes how IPsec is used to protect the signaling messages and data packets between the local mobility anchor and mobile access gateway when using IPv4 transport.

The following are the Security Policy Database (SPD) example entries to protect PBU and PBA on the local mobility anchor and mobile access gateway.

MAG SPD-S:

- IF local_address = IPv4-Proxy-CoA_1 &
remote_address = IPv4-LMAA_1 & proto = UDP &
remote_port = 5436

Then use SA ESP transport mode

LMA SPD-S:

- IF local_address = IPv4-LMAA_1 &
remote_address = IPv4-Proxy-CoA_1 & proto = UDP &
local_port = 5436

Then use SA ESP transport mode

4.3.2. Payload Packet

The following are the SPD example entries to protect payload packets on the local mobility anchor and mobile access gateway. Note that the example SPDs protect all payload packets sent to and from mobile nodes. If an operator needs to apply a different security mechanism per mobile node, they need to create a SPD and a SA entry per mobile node.

MAG SPD-S:

- IF interface = tunnel to LMAA_1 &
local_address != Proxy-CoA_1 &
remote_address != LMAA_1 & proto=any
Then use SA ESP tunnel mode

LMA SPD-S:

- IF interface = tunnel to Proxy-CoA_1 &
local_address != LMAA_1 &
remote_address != Proxy-CoA_1 & proto=any
Then use SA ESP tunnel mode

When payload packets are protected by IPsec, payload packets matching the SPDs are passed to the IPsec module and encapsulated using the tunnel mode ESP. The tunnel mode ESP encapsulated payload packets are then directly sent to the peer mobile access gateway or local mobility anchor. If IPsec is not applied to payload packets, then they are encapsulated as shown in Figures 12 and 14.

5. Protocol Configuration Variables

5.1. Local Mobility Anchor - Configuration Variables

The local mobility anchor MUST allow the following variables to be configured by the system management. The configured values for these protocol variables MUST survive server reboots and service restarts.

AcceptForcedIPv4UDPEncapsulationRequest

This flag indicates whether or not the local mobility anchor should accept IPv4 UDP encapsulation request for the mobile node's data traffic. The default value for this flag is set to (0), indicating that plain IPv4 encapsulation (without UDP) is used for data traffic.

5.2. Mobile Access Gateway - Configuration Variables

The mobile access gateway MUST allow the following variables to be configured by the system management. The configured values for these protocol variables MUST survive server reboots and service restarts.

ForceIPv4UDPEncapsulationSupport

This flag indicates whether or not the mobile access gateway should request the mobile node's local mobility anchor to use IPv4-UDP encapsulation mode for the mobile node's data traffic. The default value for this flag is set to (0), indicating that plain IPv4 encapsulation (without UDP) is used for data traffic.

6. IANA Considerations

This document defines four new Mobility Header options: the IPv4 Home Address Request option, IPv4 Home Address Reply option, IPv4 Default Router Address option, and IPv4 DHCP Support Mode option. These options are described in Sections 3.3.1, 3.3.2, 3.3.3, and 3.3.4, respectively. The Type value for these options has been assigned from the same number space as allocated for the other mobility options, as defined in [RFC3775].

The IPv4 Home Address Reply option, described in Section 3.3.2 of this document, introduces a new number space, IPv4 Home Address Reply status codes. This document currently reserves the following values. Approval of any new status code values are to be made through IANA Expert Review.

- o 0 Success
- o 128 Failure, Reason Unspecified
- o 129 Administratively prohibited
- o 130 Incorrect IPv4 home address
- o 131 Invalid IPv4 address
- o 132 Dynamic IPv4 home address assignment not available

The IPv4 DHCP Support Mode option, described in Section 3.3.4 of this document, introduces a new number space, IPv4 DHCP Support Mode Flags. This document reserves the value 0x1 for the (S) flag. Approval of flag values are to be made through IANA Expert Review. At this point in time, there are no thoughts on what the new flag allocations can be, and hence this document leaves this to the discretion of the Expert Review.

This document also defines new Status values, used in Proxy Binding Acknowledgement message, as described in Section 3.3.5. These values have been assigned from the same number space as allocated for other status codes [RFC3775]. Each of these allocated values is greater than 128.

NOT_AUTHORIZED_FOR_IPV4_MOBILITY_SERVICE: 170

Mobile node not authorized for IPv4 mobility service.

NOT_AUTHORIZED_FOR_IPV4_HOME_ADDRESS: 171

Mobile node not authorized for the requesting IPv4 home address.

NOT_AUTHORIZED_FOR_IPV6_MOBILITY_SERVICE: 172

Mobile node not authorized for IPv6 mobility service.

MULTIPLE_IPV4_HOME_ADDRESS_ASSIGNMENT_NOT_SUPPORTED: 173

Multiple IPv4 home address assignment not supported.

IANA has assigned two UDP port numbers, 5436 and 5437, for "pmip6-ctrl" and "pmip6-data", respectively.

7. Security Considerations

All the security considerations from the base Proxy Mobile IPv6 [RFC5213], Mobile IPv6 [RFC3775], and Dual-Stack Mobile IPv6 [RFC5555] specifications apply when using the extensions defined in this document. Additionally, the following security considerations need to be applied.

This document defines new mobility options for supporting the IPv4 Home Address assignment and IPv4 Transport Support features. These options are to be carried in Proxy Binding Update and Proxy Binding Acknowledgement messages. The required security mechanisms specified in the base Proxy Mobile IPv6 protocol for protecting these signaling messages are sufficient when carrying these mobility options.

This specification describes the use of IPv4 transport for exchanging signaling messages between the local mobility anchor and the mobile access gateway. These can be protected using IPsec as described in Section 4.3.

8. Contributors

This document reflects discussions and contributions from several people (in alphabetical order):

Kuntal Chowdhury

kchowdhury@starentnetworks.com

Vijay Devarapalli

vijay.devarapalli@azairenet.com

Pasi Eronen

Pasi.Eronen@nokia.com

Sangjin Jeong

sjjeong@etri.re.kr

Basavaraj Patil

basavaraj.patil@nokia.com

Myungki Shin

myungki.shin@gmail.com

9. Acknowledgements

The IPv4 support for Proxy Mobile IPv6 was initially covered in "Proxy Mobile IPv6" (March 2007). We would like to thank all the authors of the document and acknowledge that initial work.

Thanks to Alper Yegin, Behcet Sarikaya, Bernard Aboba, Charles Perkins, Damic Damjan, Jari Arkko, Joel Hortelius, Jonne Soinnen, Julien Laganier, Mohana Jeyatharan, Niklas Nuemann, Pasi Eronen, Premec Domagoj, Ralph Droms, Sammy Touati, Vidya Narayanan, Yingzhe Wu, and Zu Qiang for their helpful review of this document.

Also, we would like to thank Spencer Dawkins, Tim Polk, Menachem Dodge, Adrian Farrel, and Pekka Savola for their reviews of this document as part of the IESG review process. Finally, special thanks to Jouni Korhonen for his support in addressing the IPsec issues.

10. References

10.1. Normative References

- [RFC2119] Bradner, S., "Key words for use in RFCs to Indicate Requirement Levels", BCP 14, RFC 2119, March 1997.
- [RFC2131] Droms, R., "Dynamic Host Configuration Protocol", RFC 2131, March 1997.
- [RFC2132] Alexander, S. and R. Droms, "DHCP Options and BOOTP Vendor Extensions", RFC 2132, March 1997.
- [RFC2473] Conta, A. and S. Deering, "Generic Packet Tunneling in IPv6 Specification", RFC 2473, December 1998.

- [RFC3046] Patrick, M., "DHCP Relay Agent Information Option", RFC 3046, January 2001.
- [RFC3775] Johnson, D., Perkins, C., and J. Arkko, "Mobility Support in IPv6", RFC 3775, June 2004.
- [RFC4213] Nordmark, E. and R. Gilligan, "Basic Transition Mechanisms for IPv6 Hosts and Routers", RFC 4213, October 2005.
- [RFC4361] Lemon, T. and B. Sommerfeld, "Node-specific Client Identifiers for Dynamic Host Configuration Protocol Version Four (DHCPv4)", RFC 4361, February 2006.
- [RFC5107] Johnson, R., Kumarasamy, J., Kinnear, K., and M. Stapp, "DHCP Server Identifier Override Suboption", RFC 5107, February 2008.
- [RFC5213] Gundavelli, S., Leung, K., Devarapalli, V., Chowdhury, K., and B. Patil, "Proxy Mobile IPv6", RFC 5213, August 2008.
- [RFC5555] Soliman, H., "Mobile IPv6 Support for Dual Stack Hosts and Routers", RFC 5555, June 2009.

10.2. Informative References

- [RFC0925] Postel, J., "Multi-LAN address resolution", RFC 925, October 1984.
- [RFC1332] McGregor, G., "The PPP Internet Protocol Control Protocol (IPCP)", RFC 1332, May 1992.
- [RFC1918] Rekhter, Y., Moskowitz, R., Karrenberg, D., Groot, G., and E. Lear, "Address Allocation for Private Internets", BCP 5, RFC 1918, February 1996.
- [RFC3022] Srisuresh, P. and K. Egevang, "Traditional IP Network Address Translator (Traditional NAT)", RFC 3022, January 2001.
- [RFC4306] Kaufman, C., "Internet Key Exchange (IKEv2) Protocol", RFC 4306, December 2005.
- [RFC4436] Aboba, B., Carlson, J., and S. Cheshire, "Detecting Network Attachment in IPv4 (DNAV4)", RFC 4436, March 2006.
- [RFC4977] Tsirtsis, G. and H. Soliman, "Problem Statement: Dual Stack Mobility", RFC 4977, August 2007.

[GREKEY] Muhanna, A., Khalil, M., Gundavelli, S., and K. Leung,
"GRE Key Option for Proxy Mobile IPv6", Work in Progress,
May 2009.

Authors' Addresses

Ryuji Wakikawa
TOYOTA InfoTechnology Center, U.S.A., Inc.
465 Bernardo Avenue
Mountain View, CA 94043
USA

EEmail: ryuji@us.toyota-itc.com

Sri Gundavelli
Cisco
170 West Tasman Drive
San Jose, CA 95134
USA

EEmail: sgundave@cisco.com